

The End of Architecture

Amorphous, Entropic, Plasticity

OSHER at CMU

Matthew Schlueb, Instructor

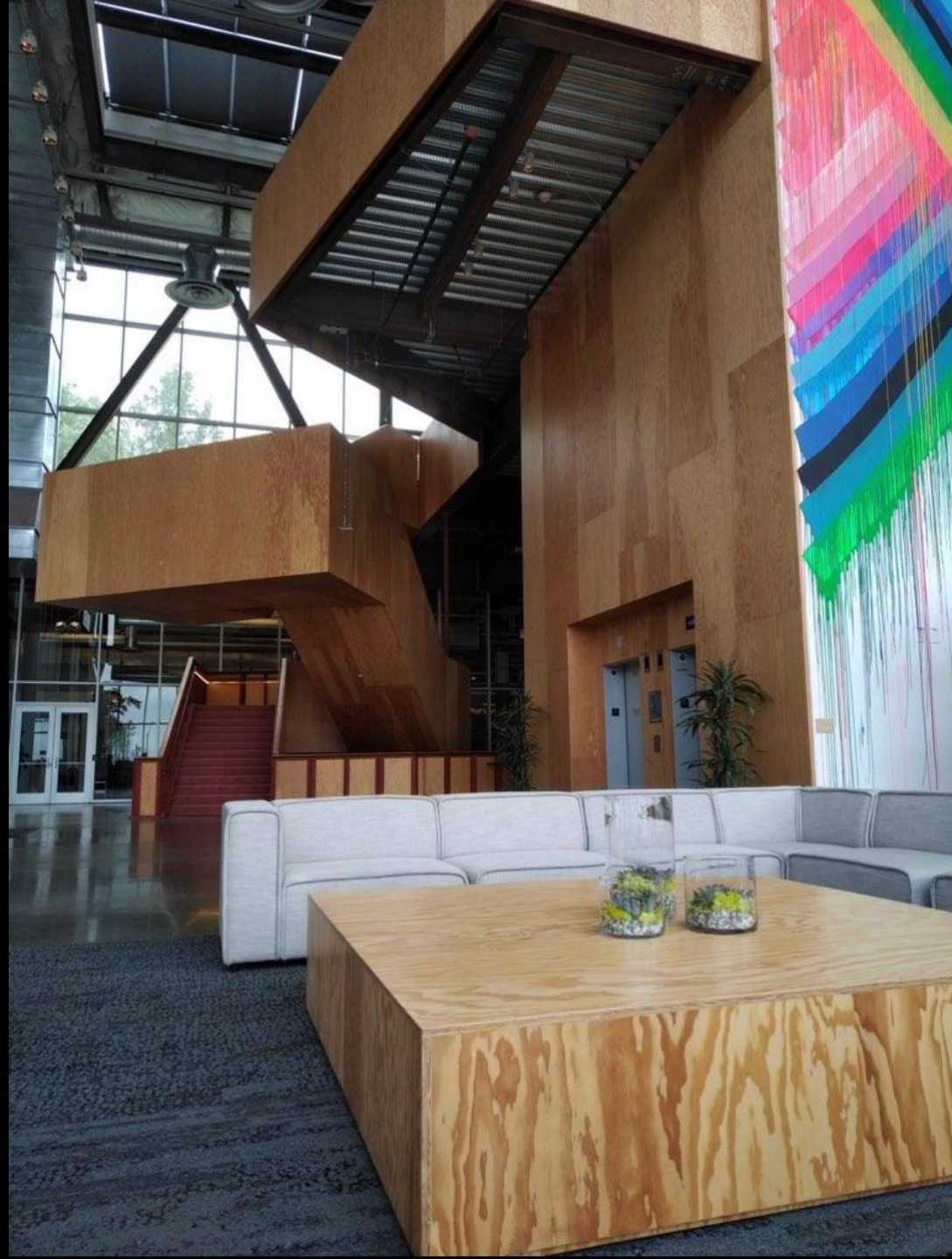
Lecture 4 - Philippe Block

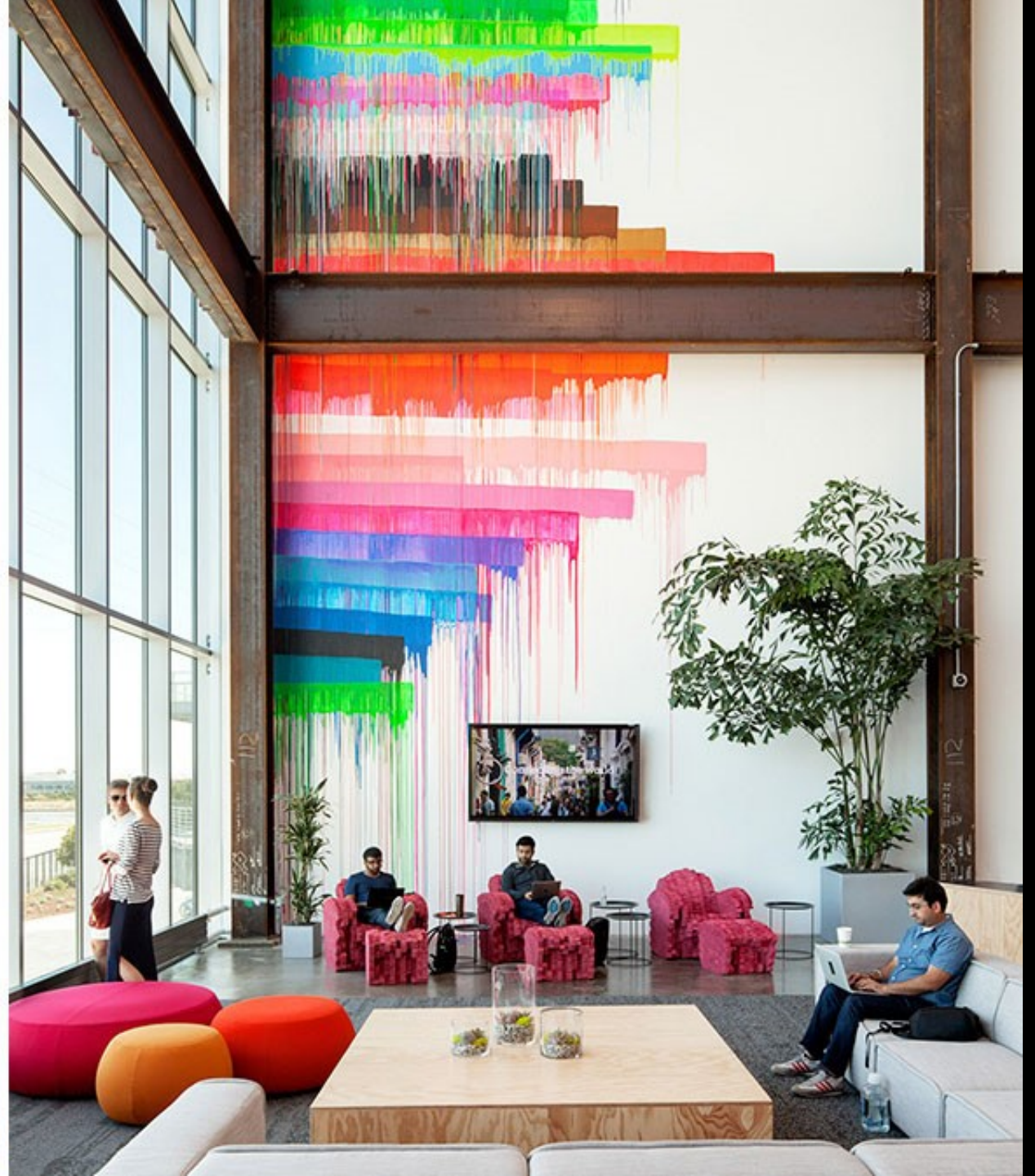
Cyert Hall - 2023.07.19







































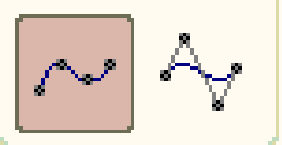






Studio Spline

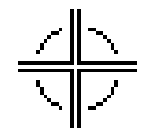
Method

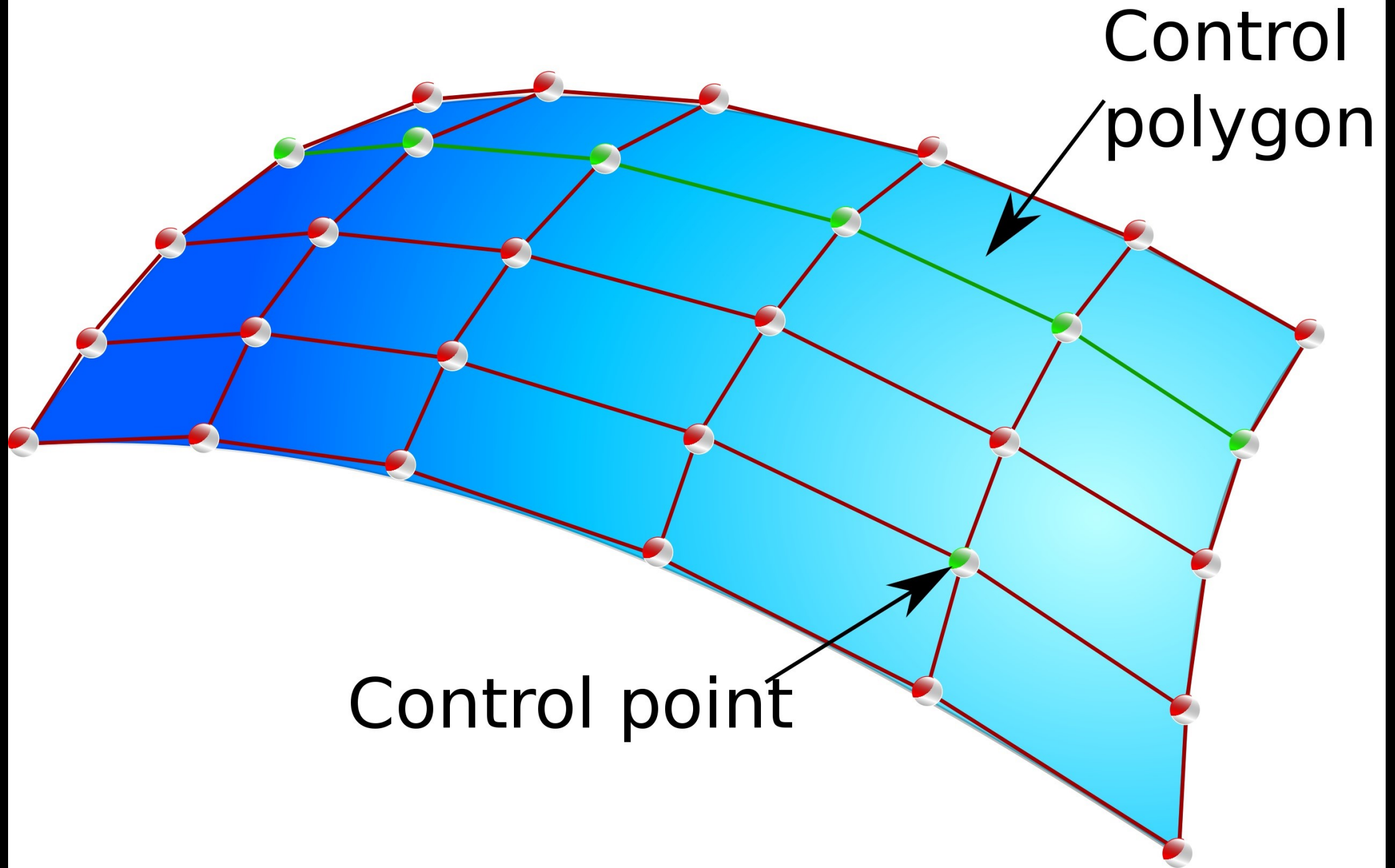


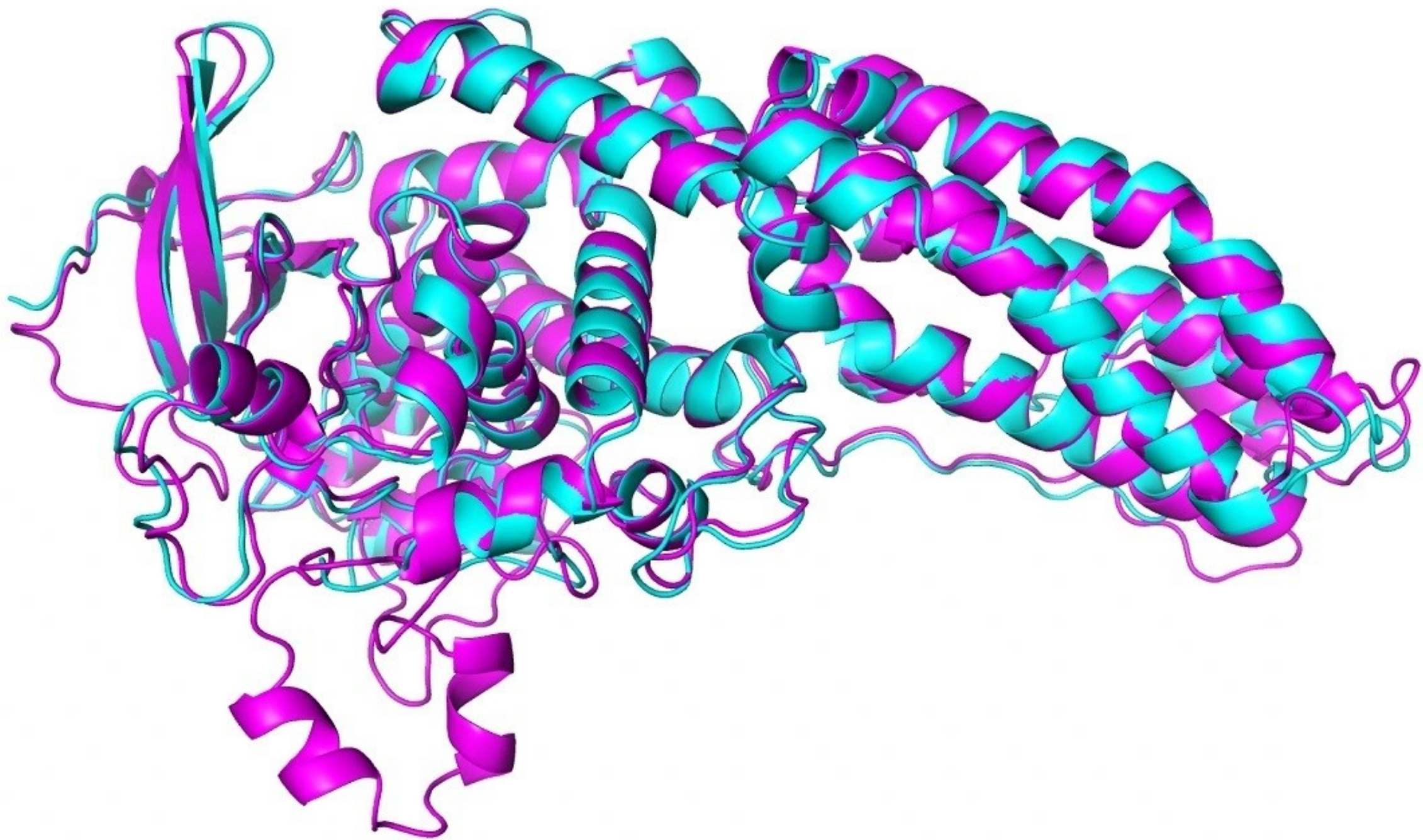
- Single Segment
- Matched Knot Position
- Closed
- Associative

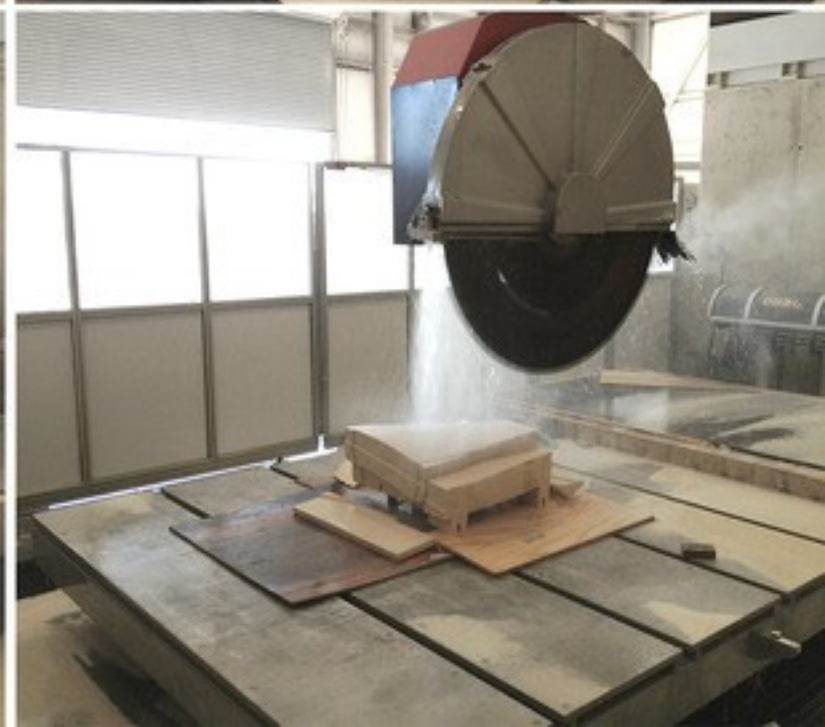
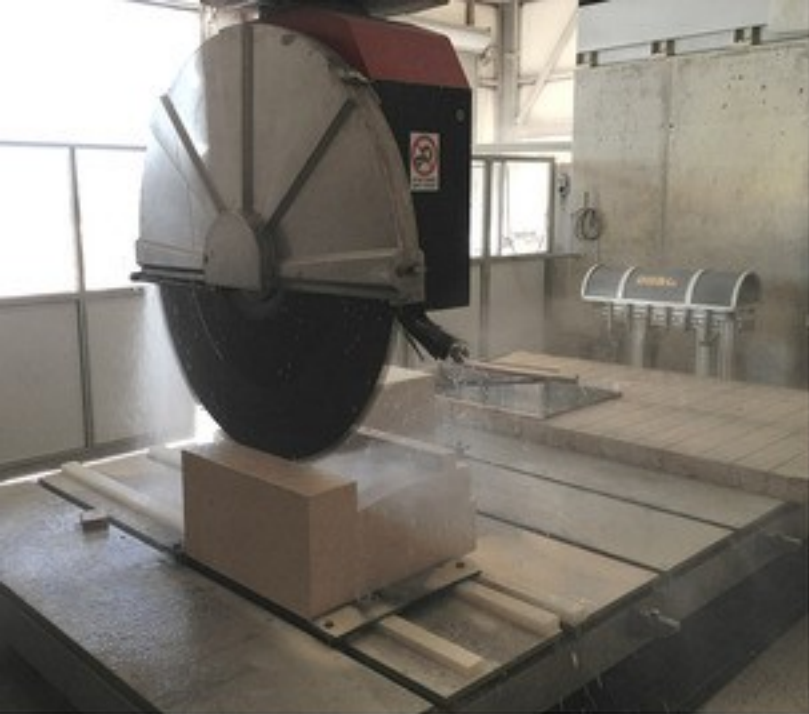
Degree 3

OK Apply Cancel









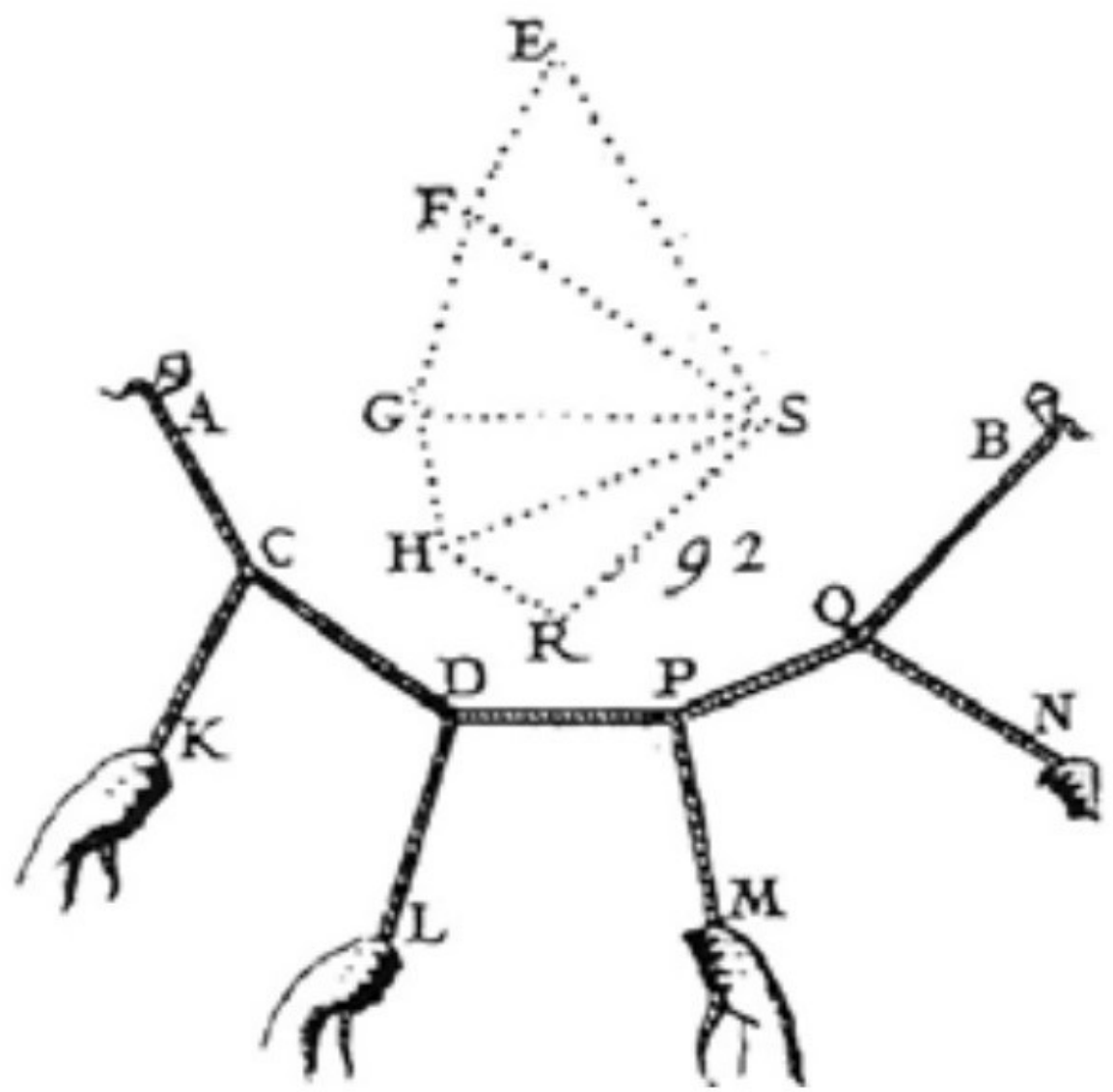
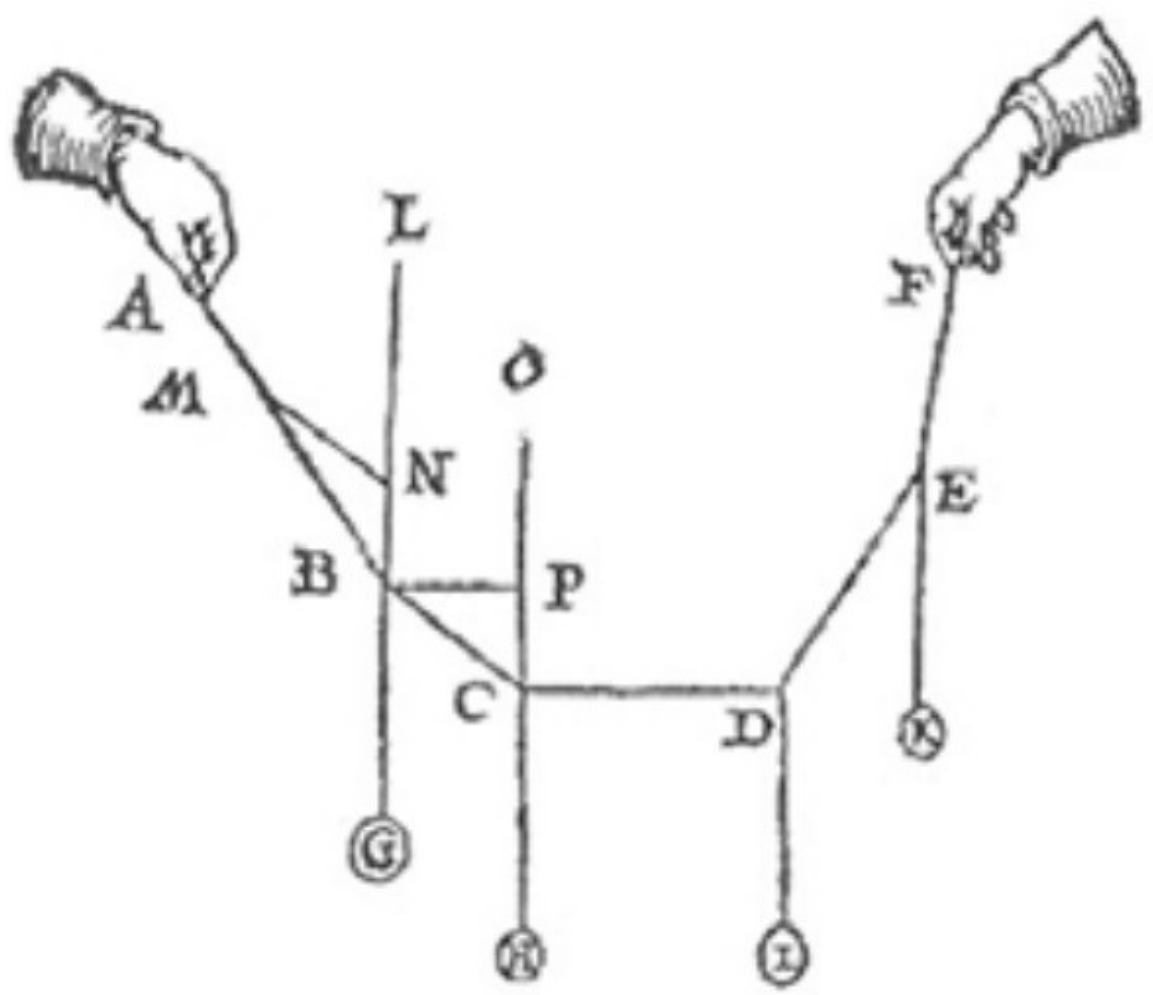












Robert Hooke's hanging chain. Robert Hooke (1635-1703) described the relationship between a hanging chain, which forms a catenary in tension under its own weight, and an arch, which stands in compression (fig. 1a).

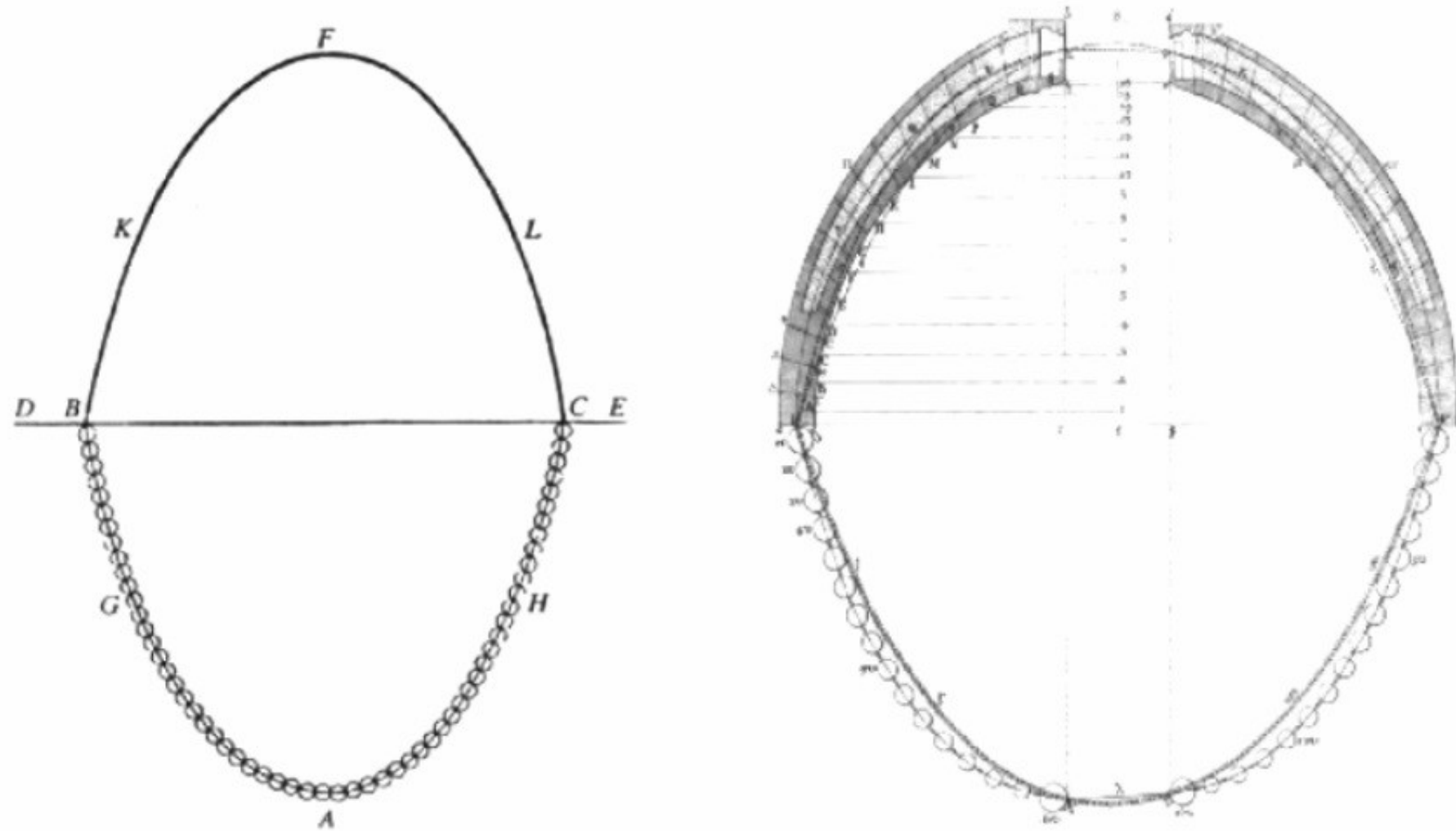
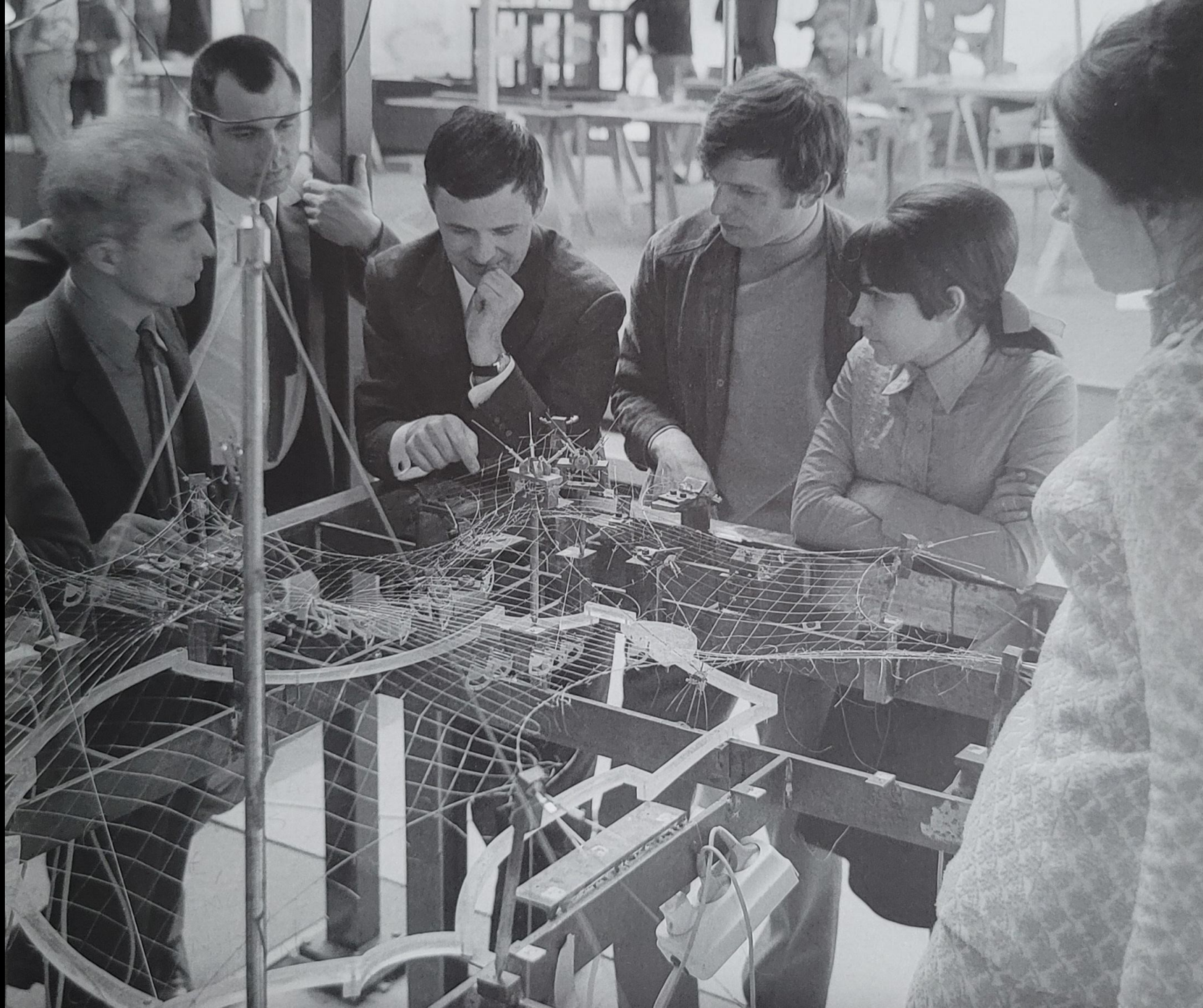


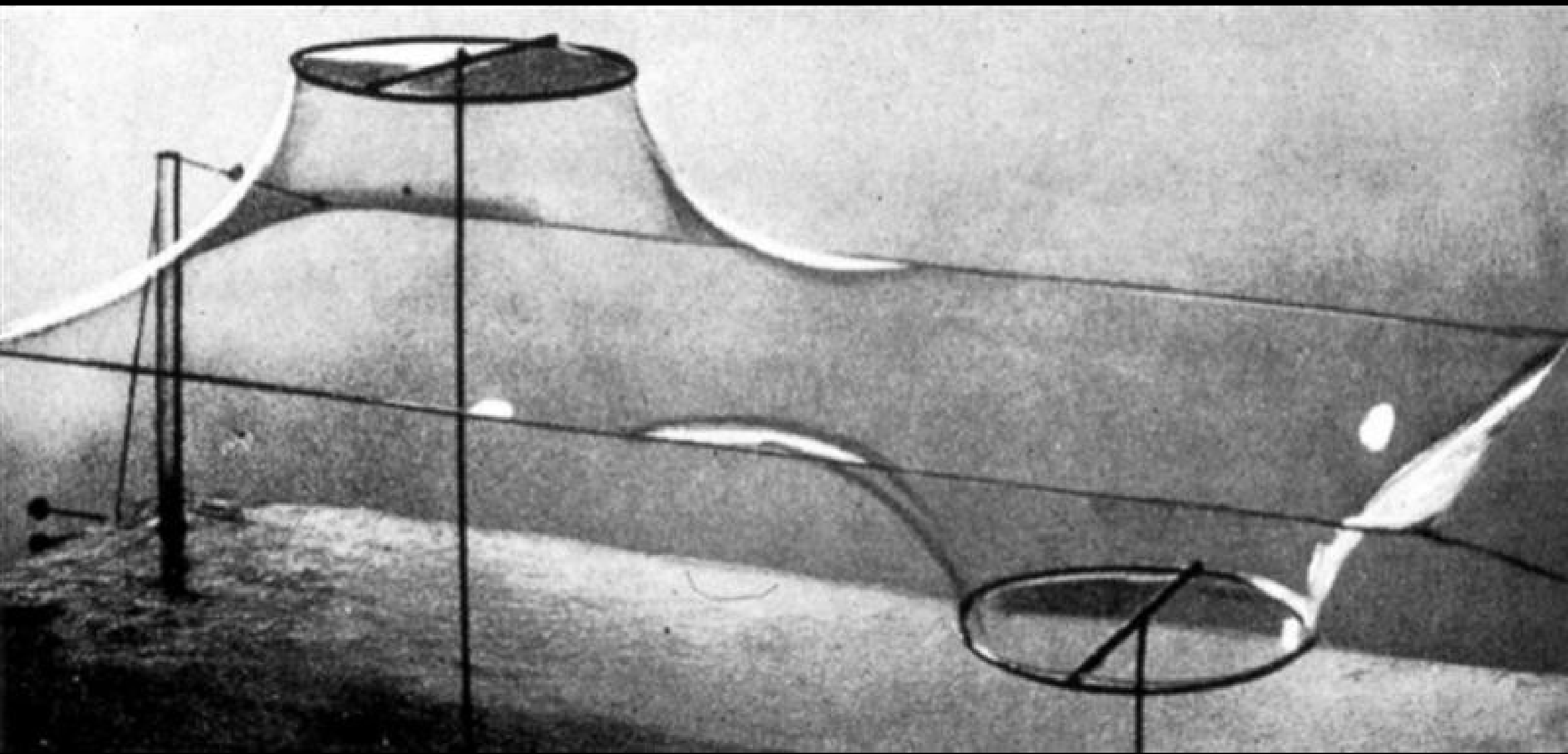
Fig. 1. (a) Poleni's drawing of Hooke's analogy between an arch and a hanging chain, and (b) his analysis of the Dome of St.-Peter's in Rome [1748]

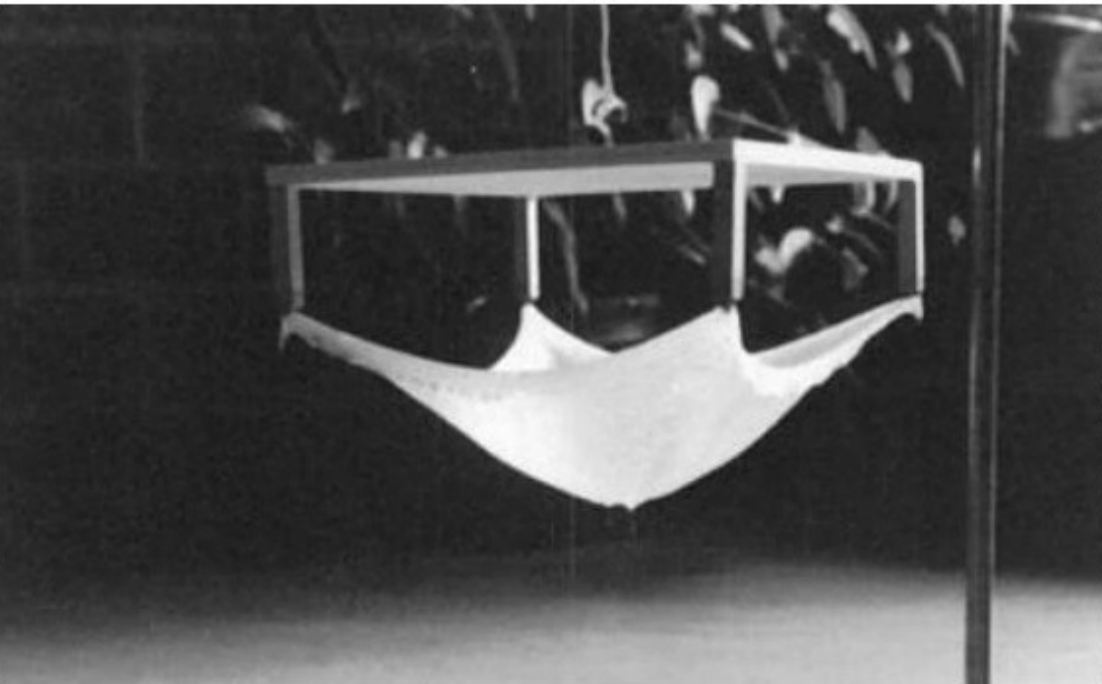


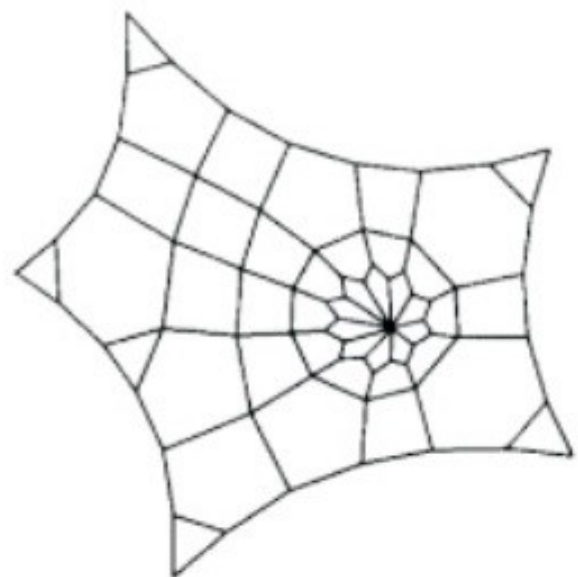
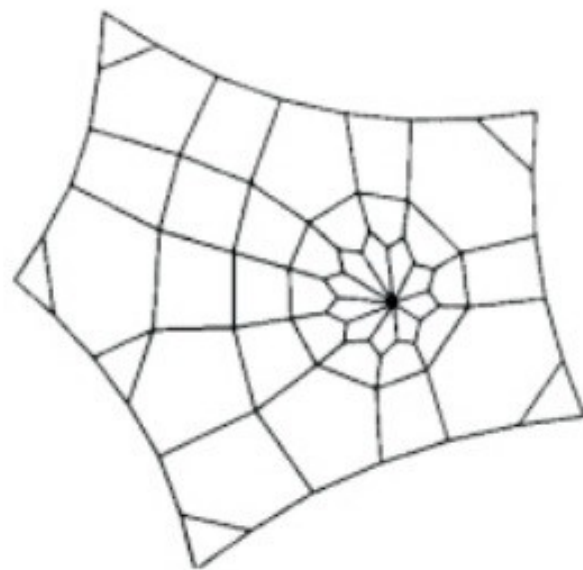
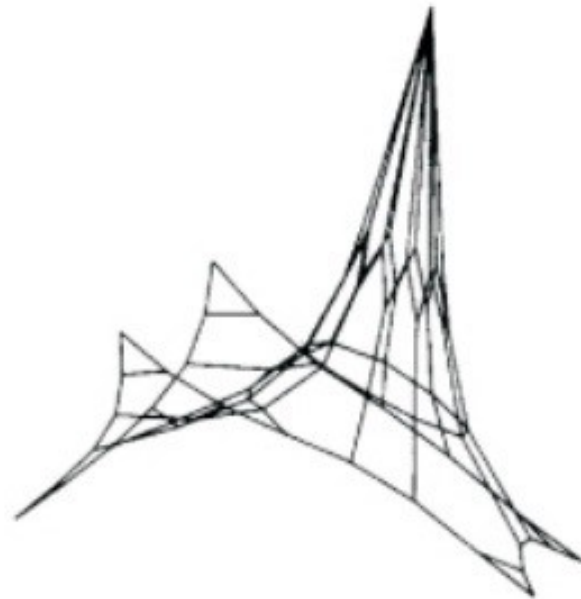
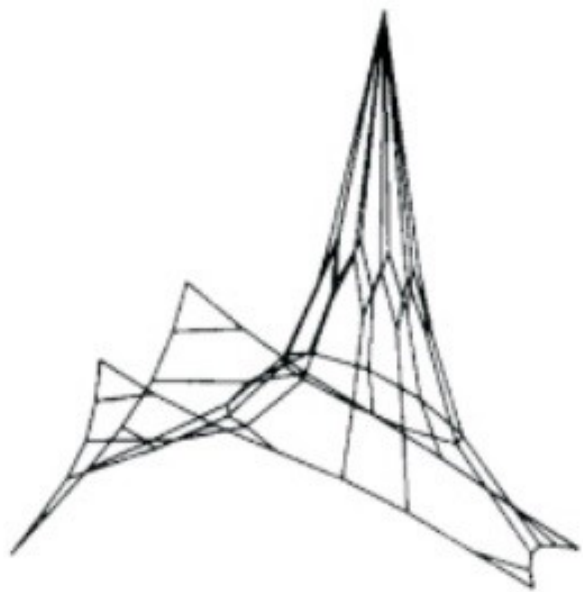
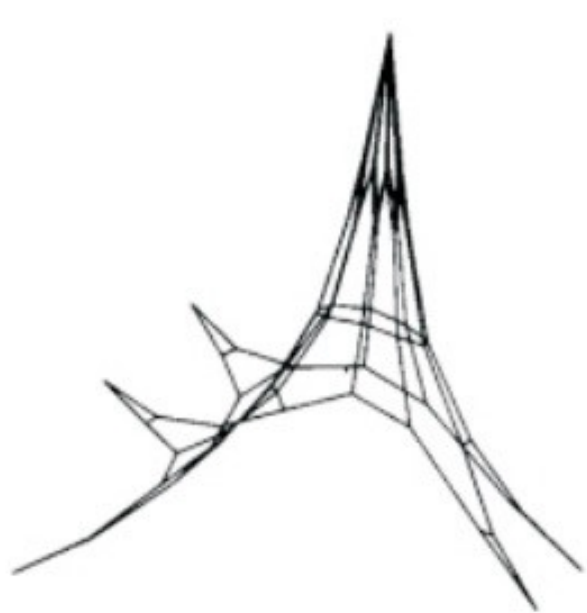


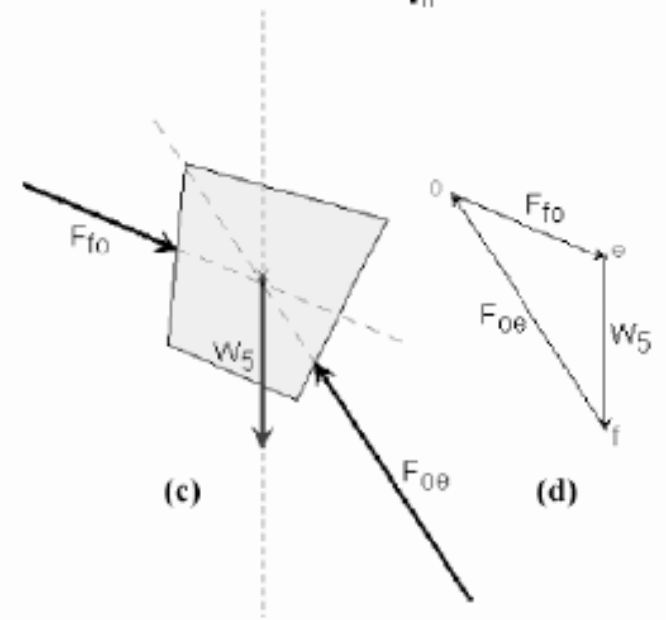
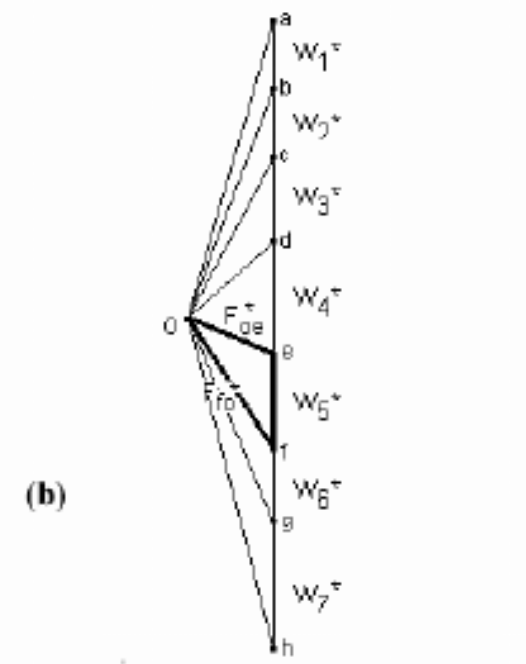
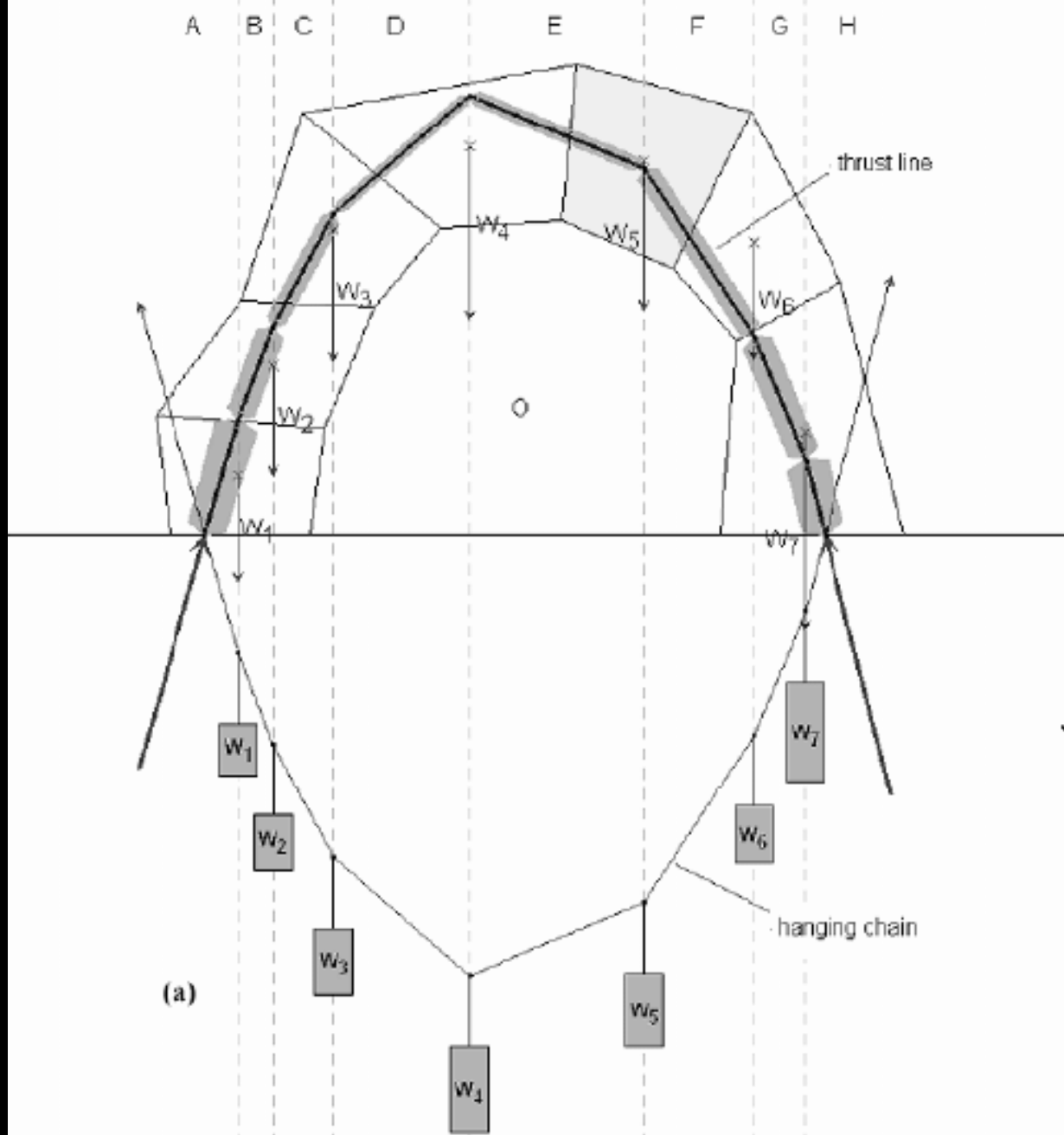


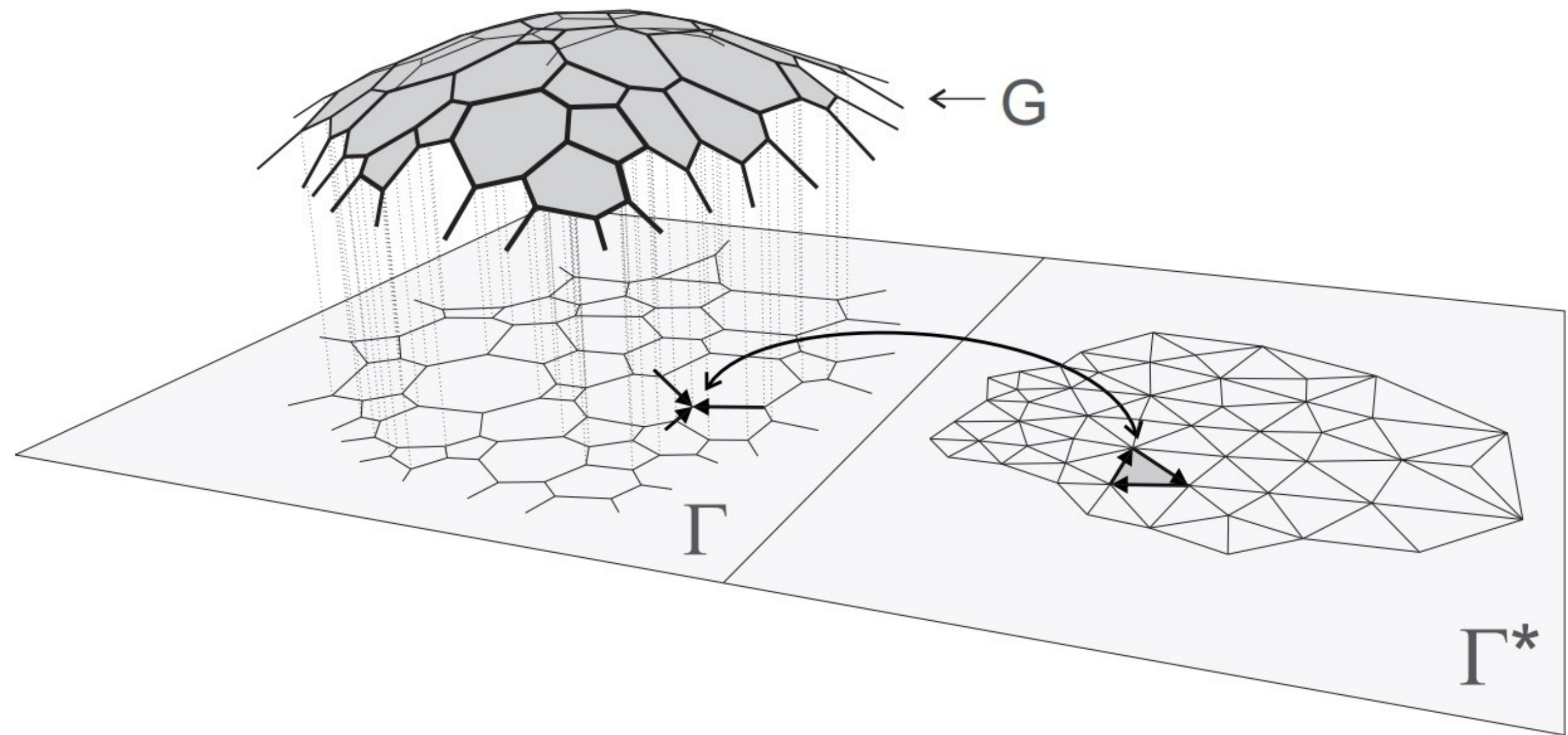


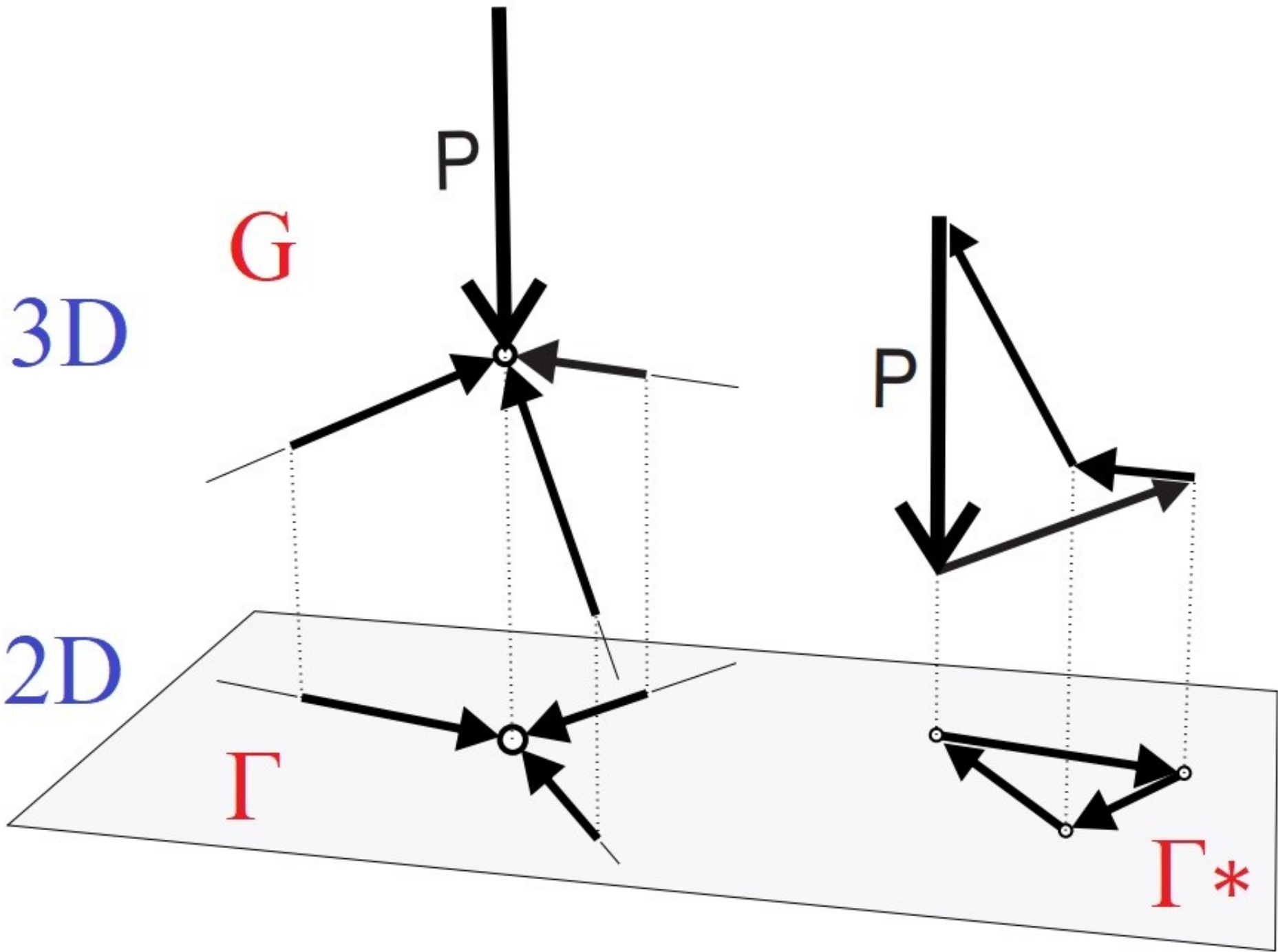












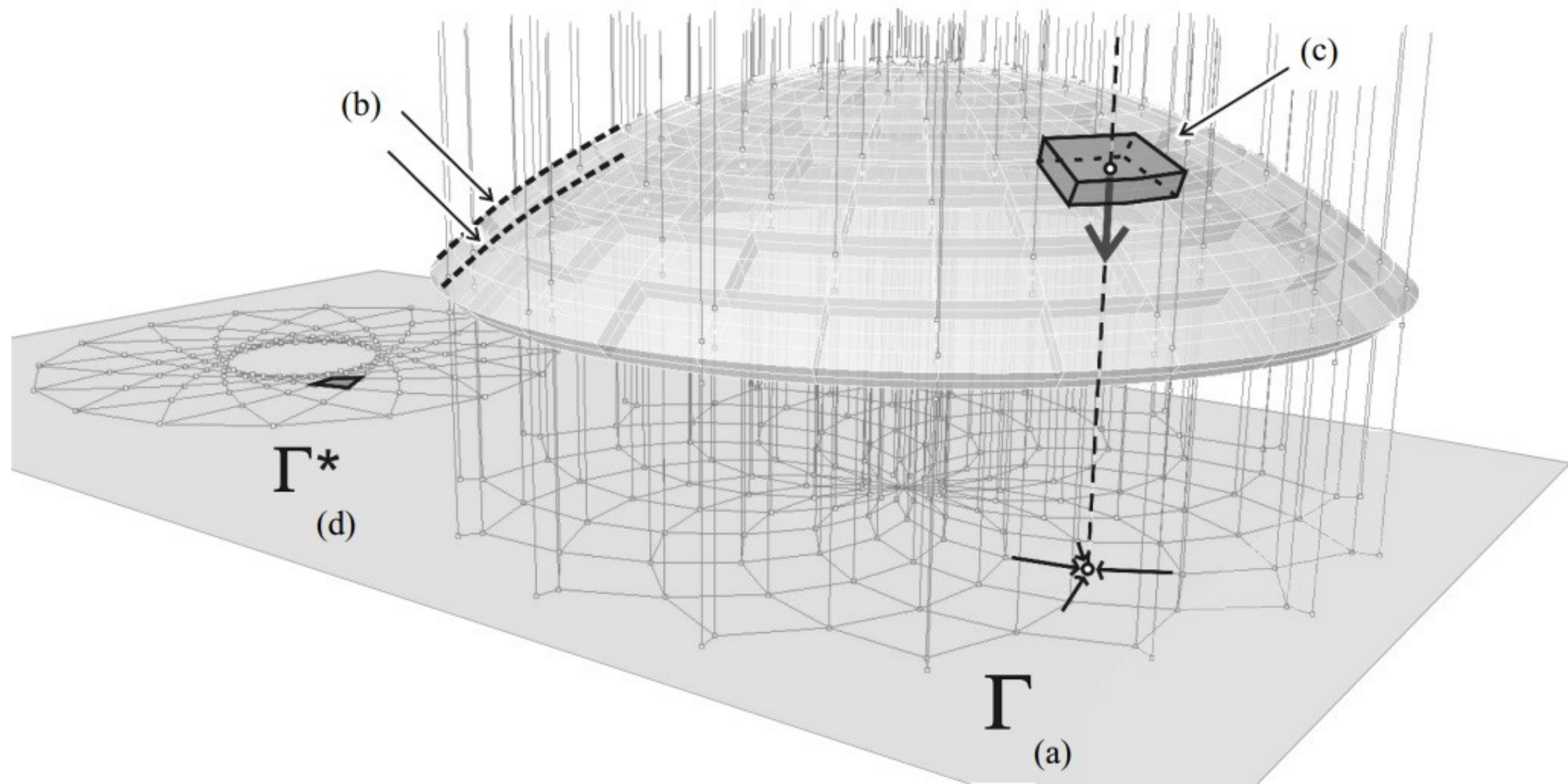


Figure 3.9 – Input for Thrust Network Analysis: (a) a possible force pattern Γ , defined on the horizontal plane; and (b) the boundaries, the intrados and extrados of a masonry vault. (c) The weight associated per node comes from the vault's self-weight and other imposed loads. (d) A possible reciprocal force diagram Γ^* is produced from Γ .

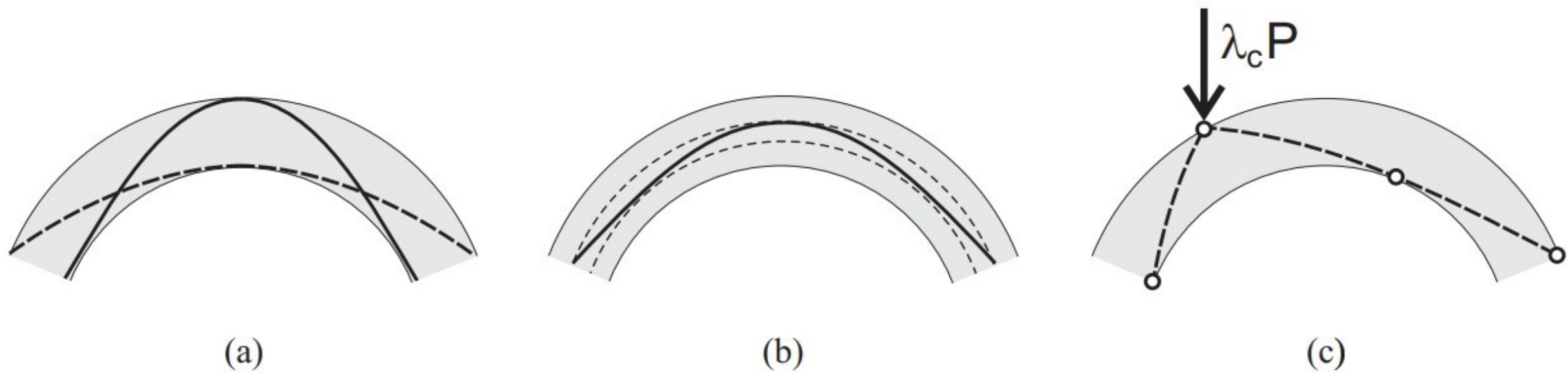


Figure 5.1 – Some possible objective functions: (a) min/max thrust, (b) geometric safety factor, and (c) collapse load factor.

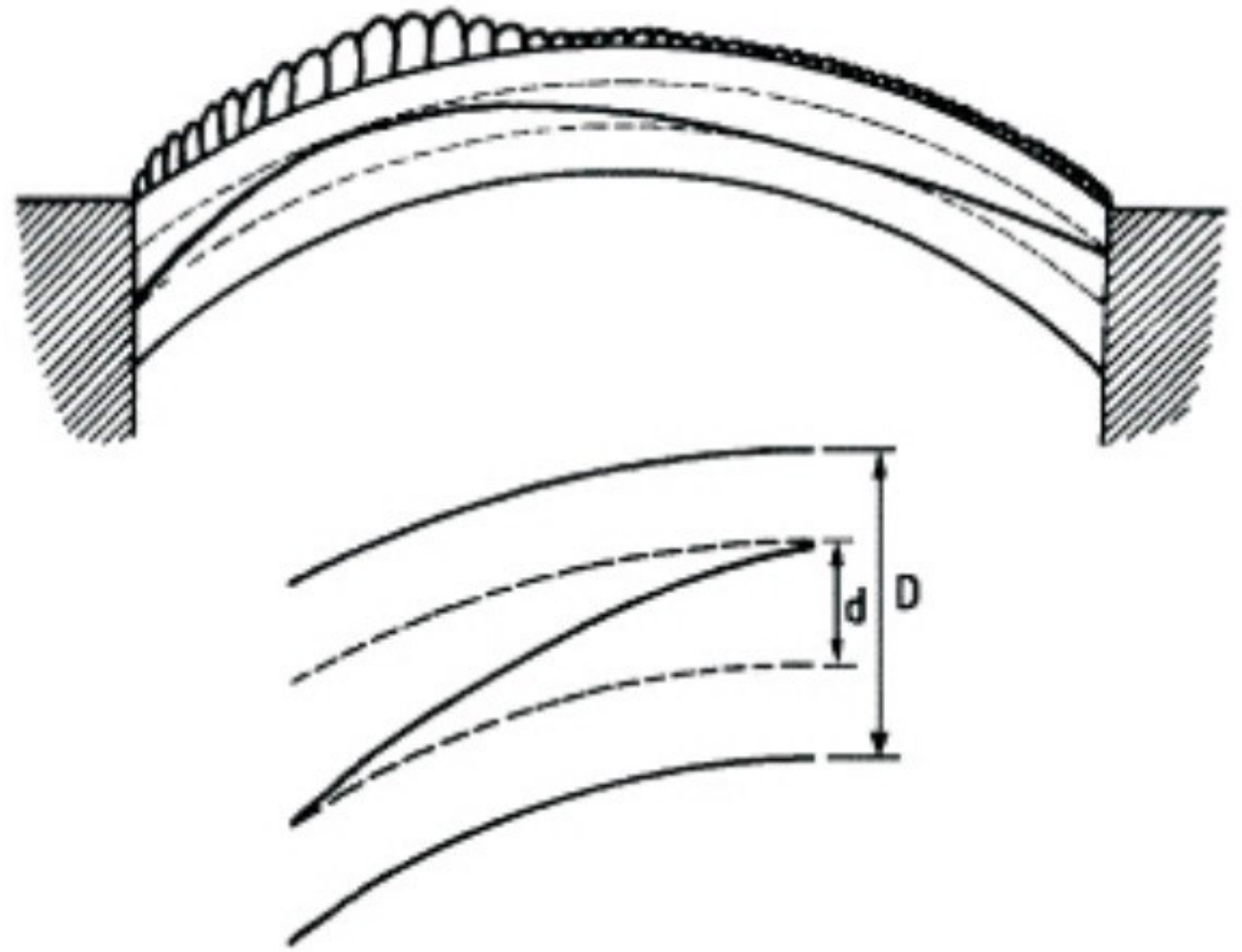


Figure 5.2 – Definition of the geometric safety factor [O'Dwyer, 1999].

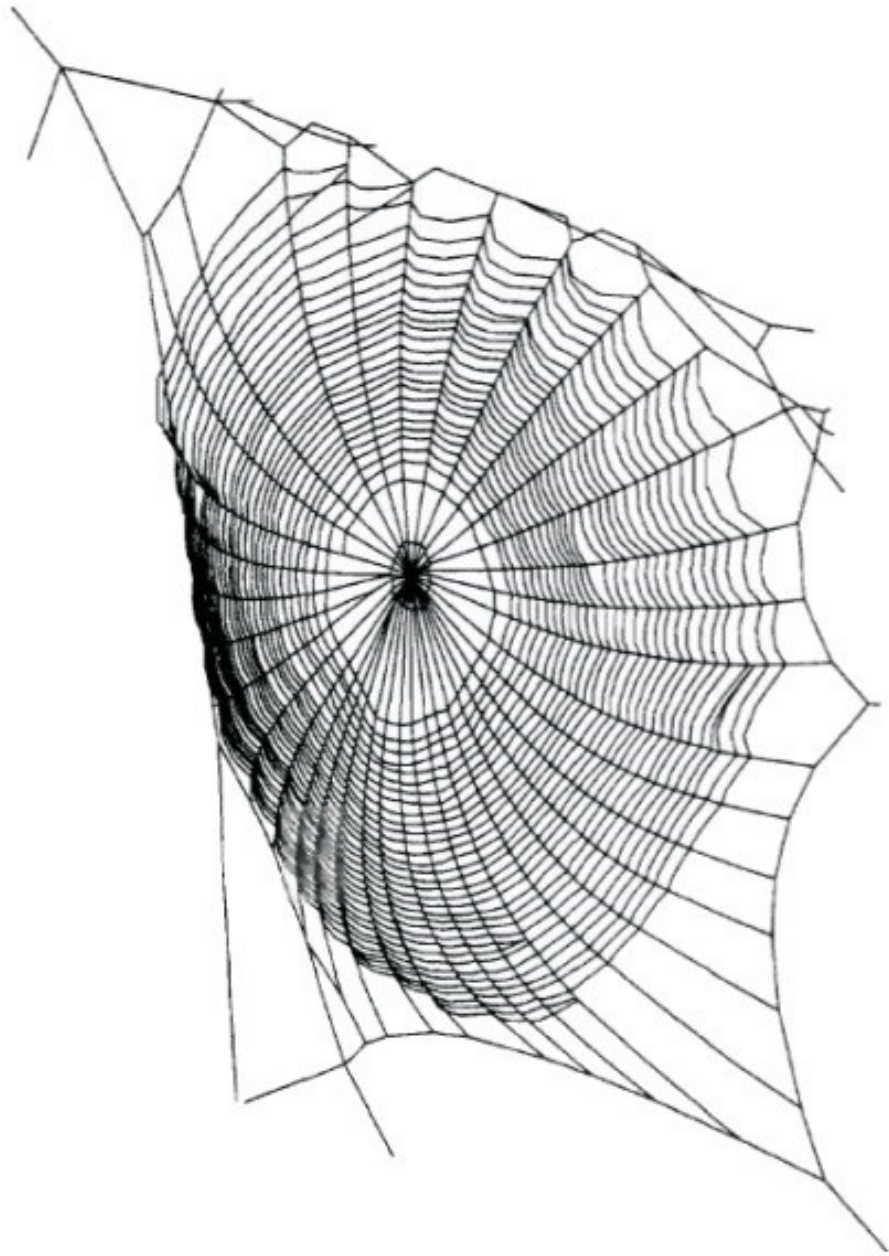
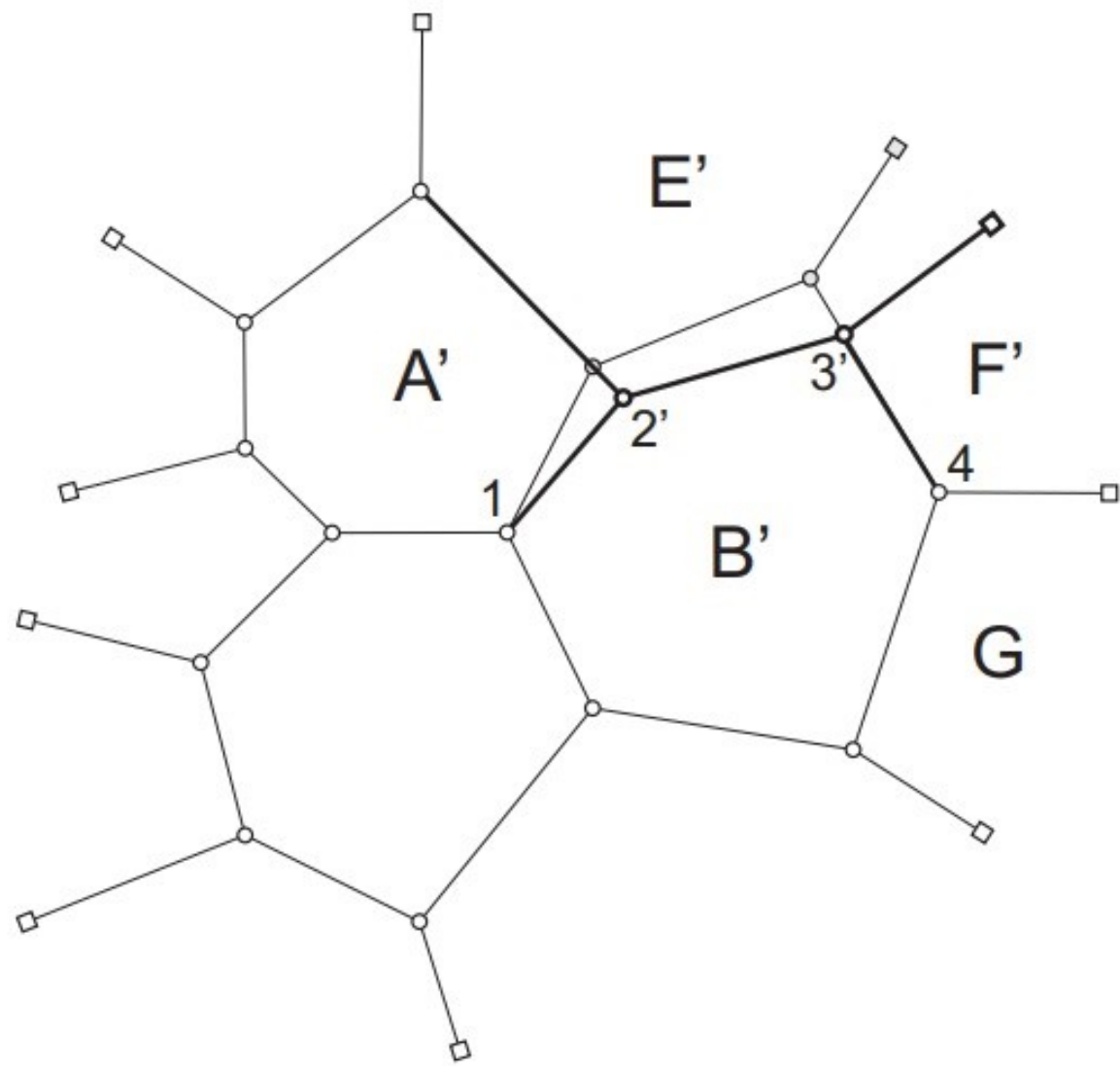
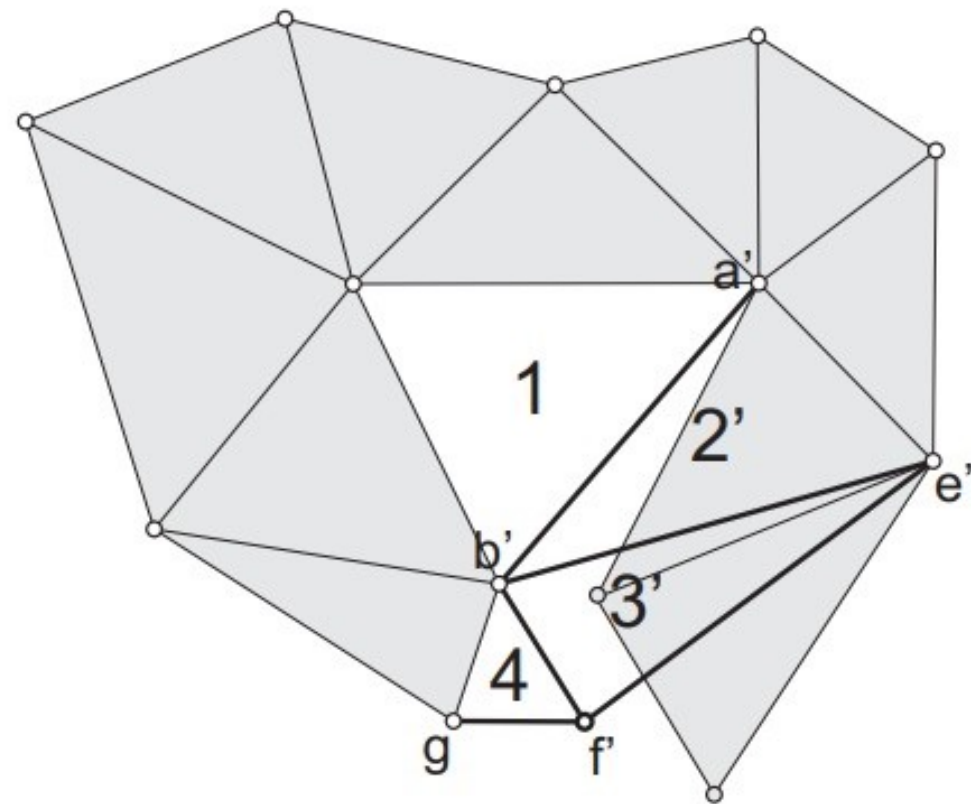


Figure 4.6 – A deformed spider web in nature, loaded out-of plane by the wind [Lin and Sobek, 1998].

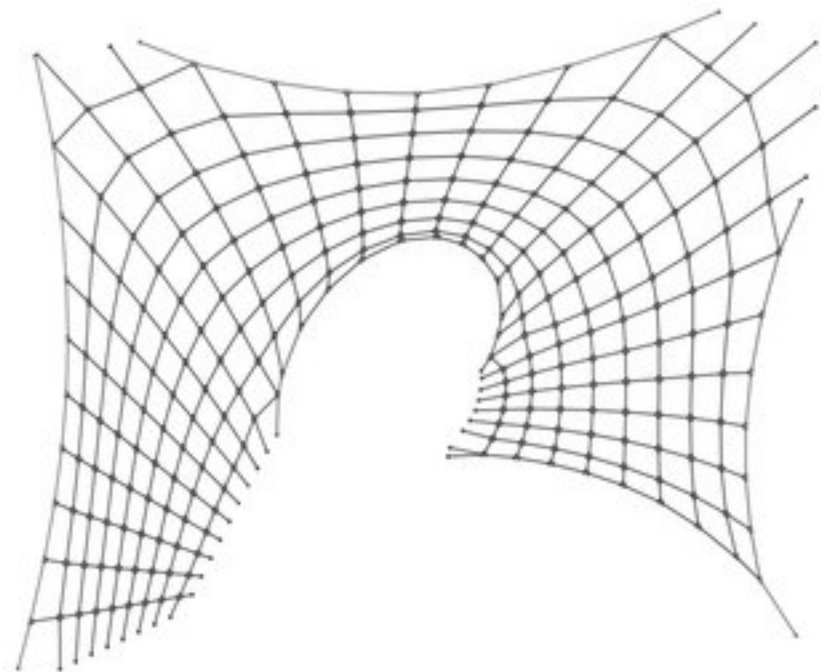


(a)

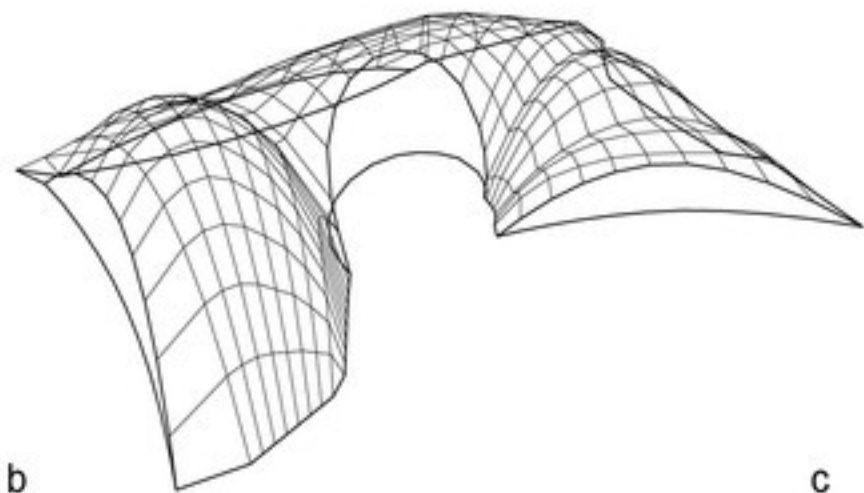


(b)

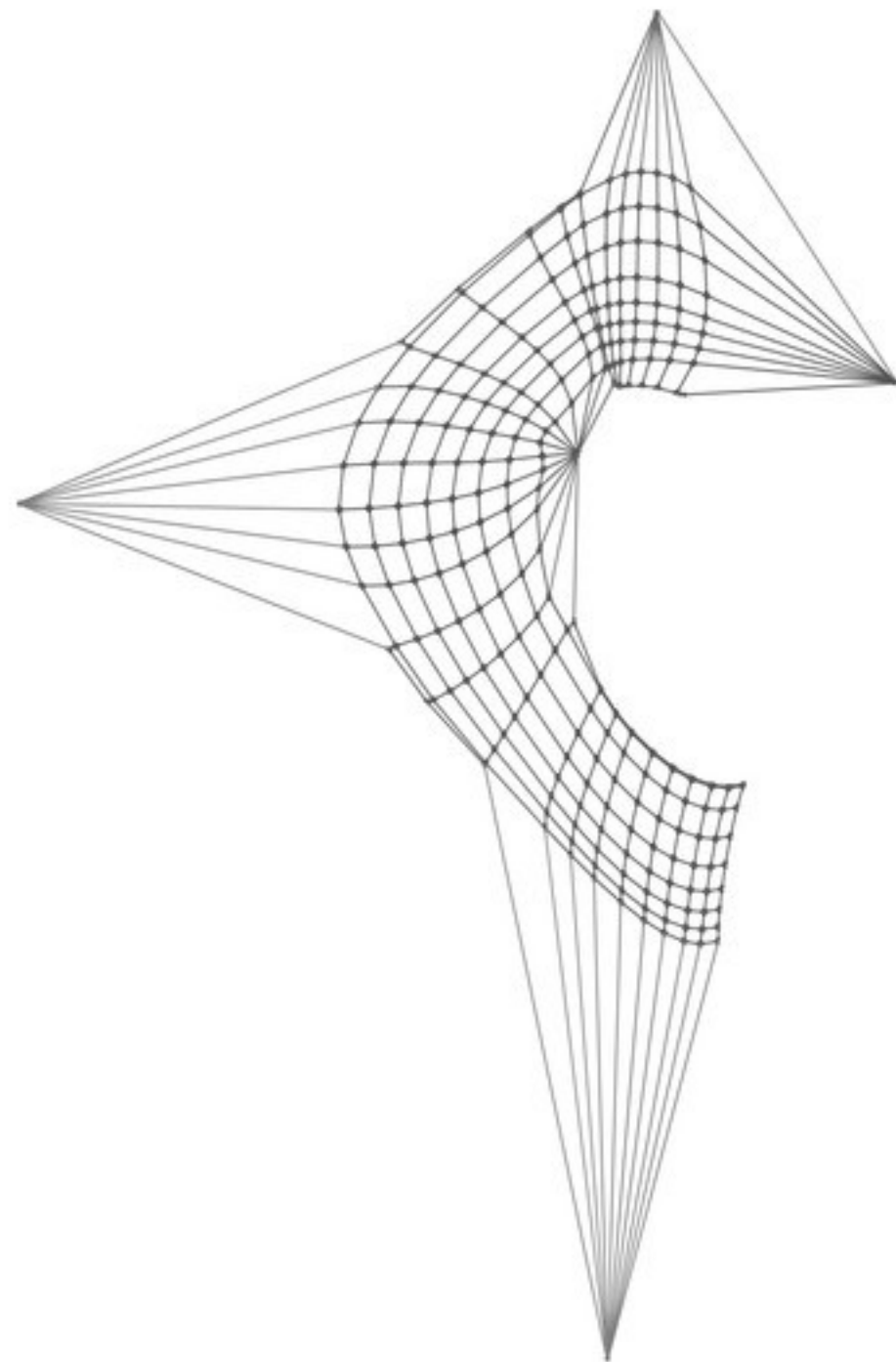
Figure 4.5 – (a) A three-valent grid not in equilibrium: (b) its reciprocal does not close, and a possible “correction” (in bold).



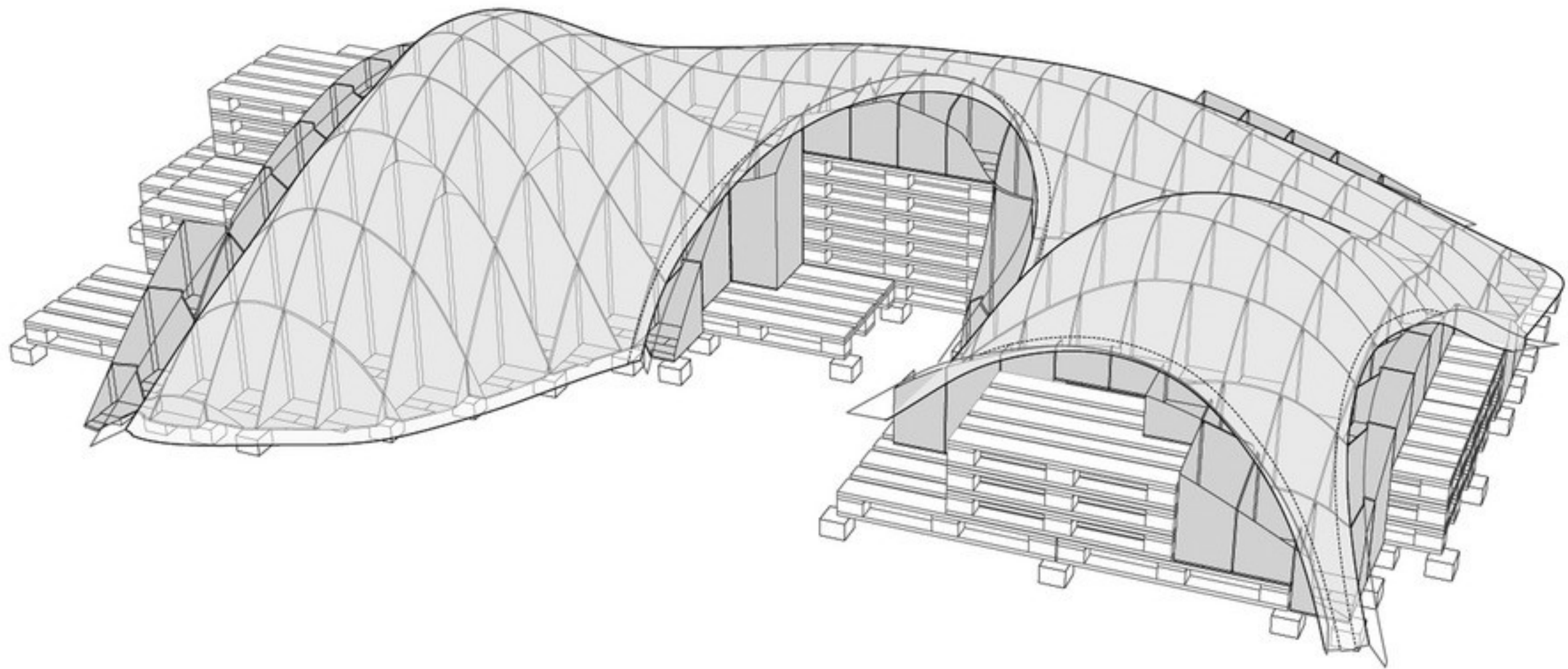
a



b



c











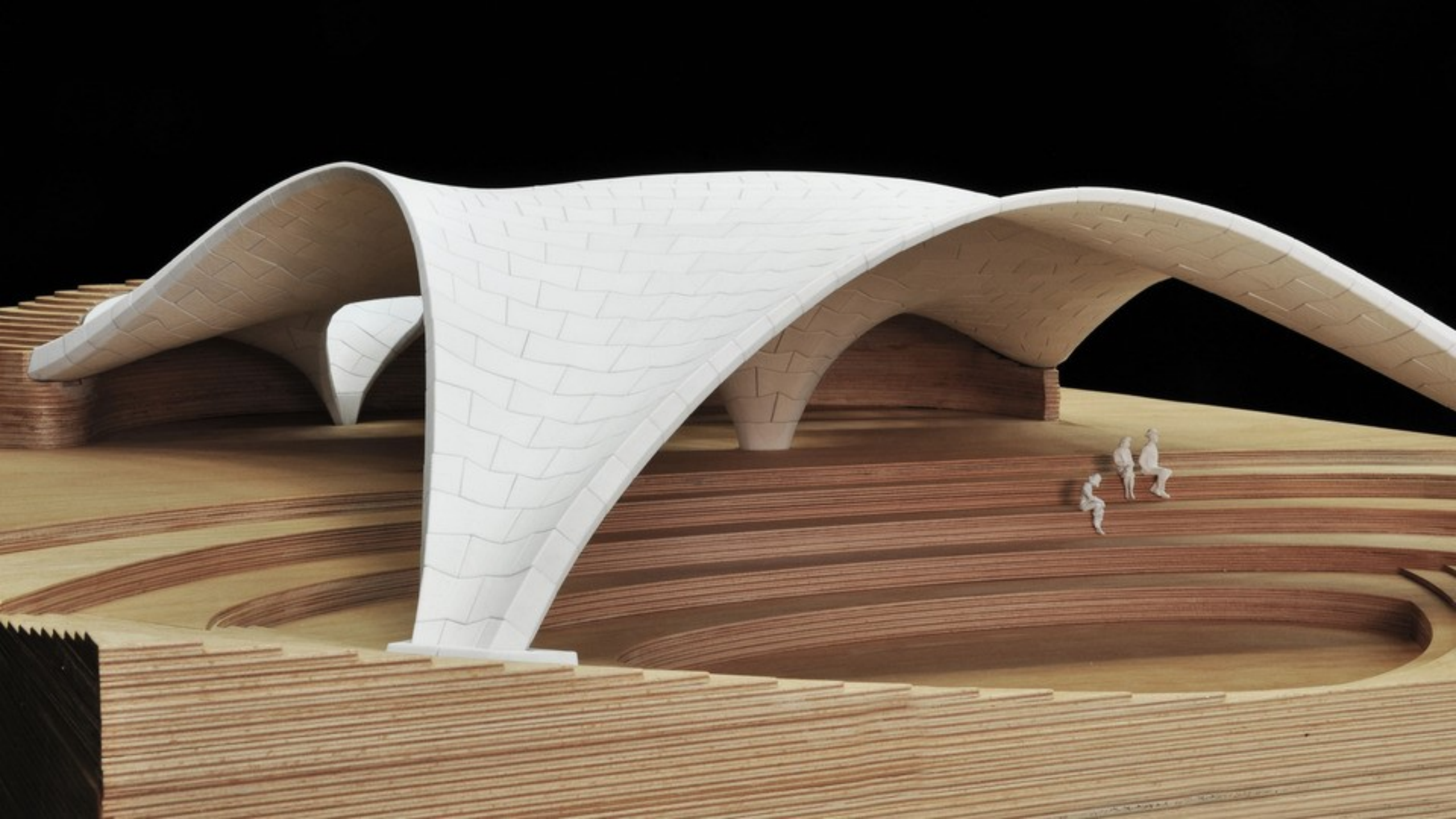


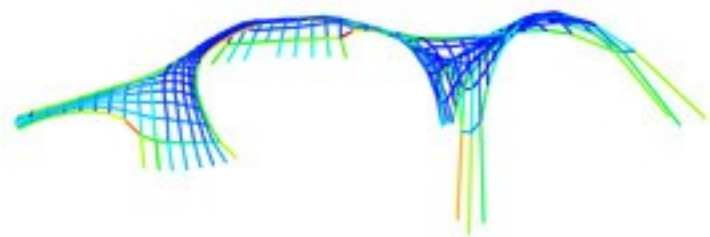




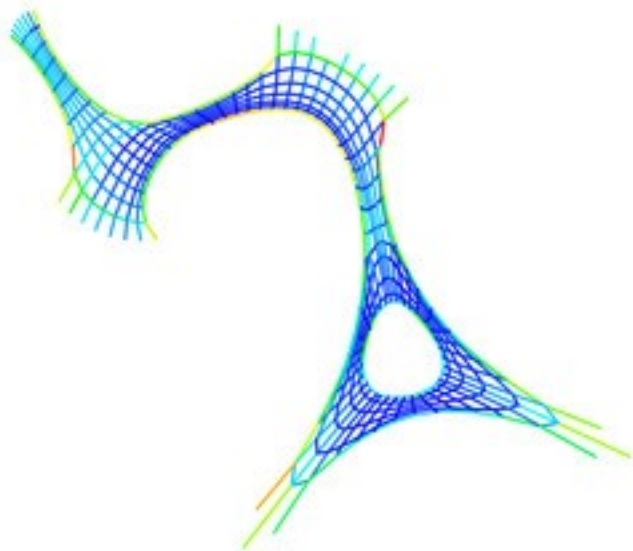




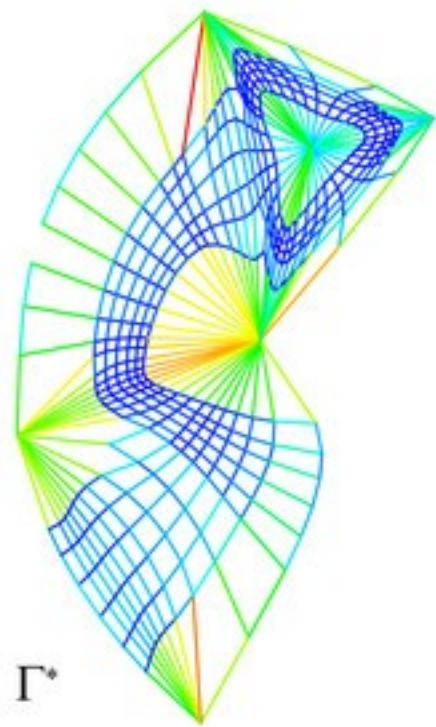




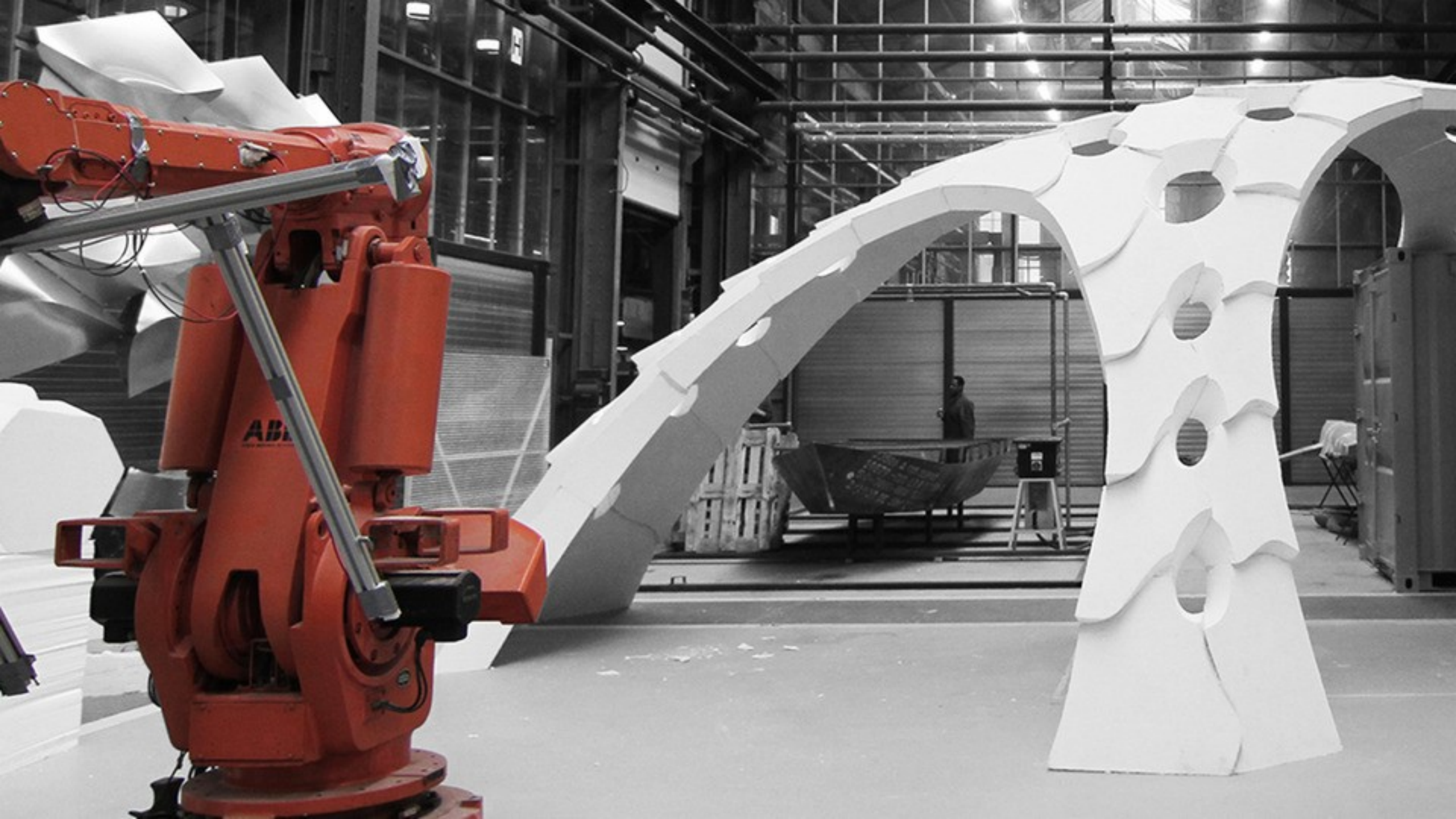
G

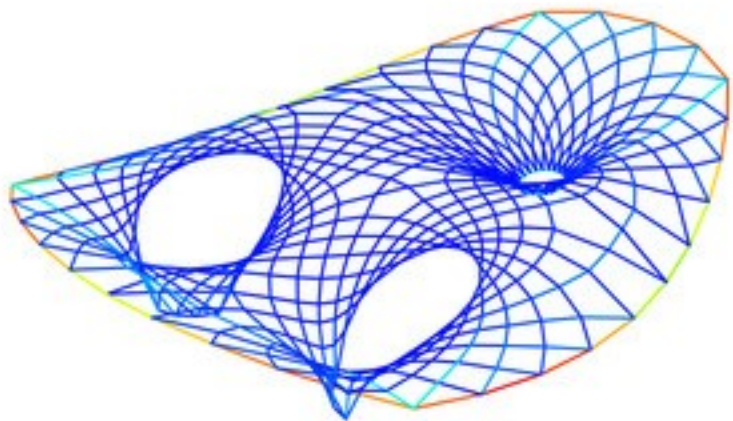


Γ

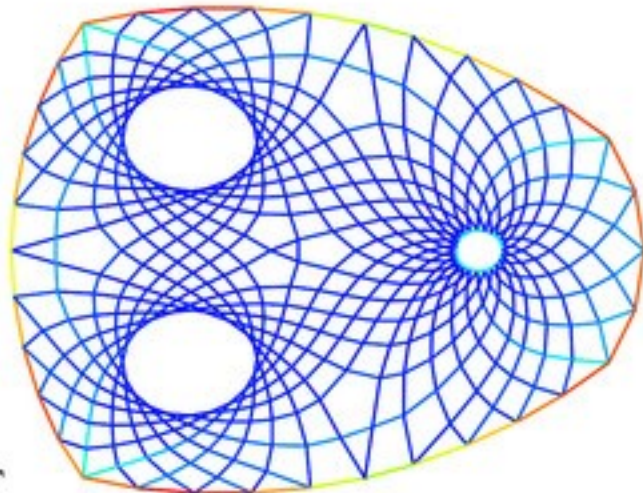


Γ^*

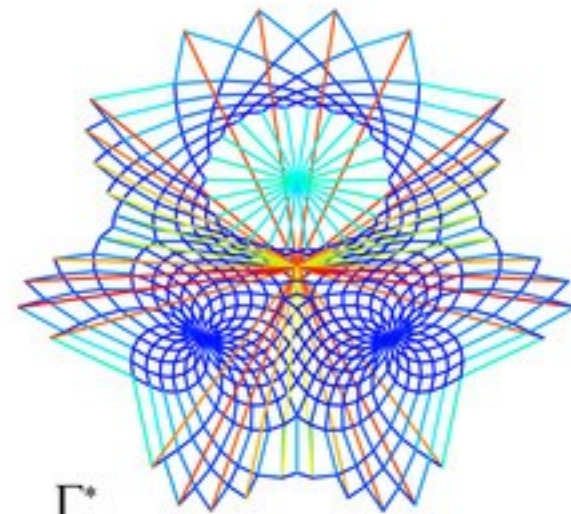




G

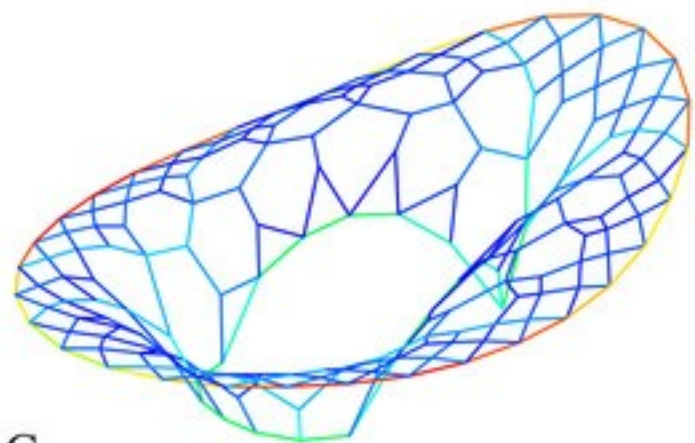


Γ

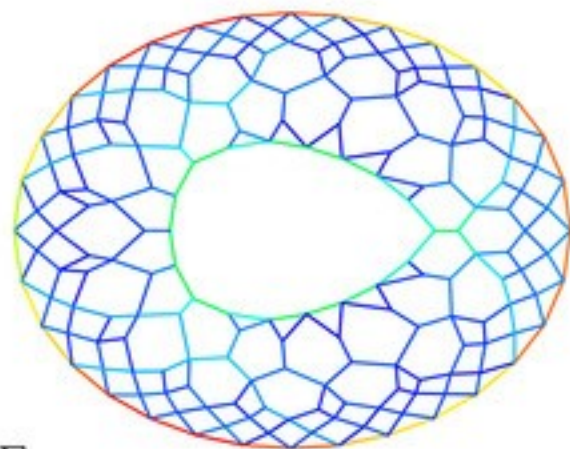


Γ^*

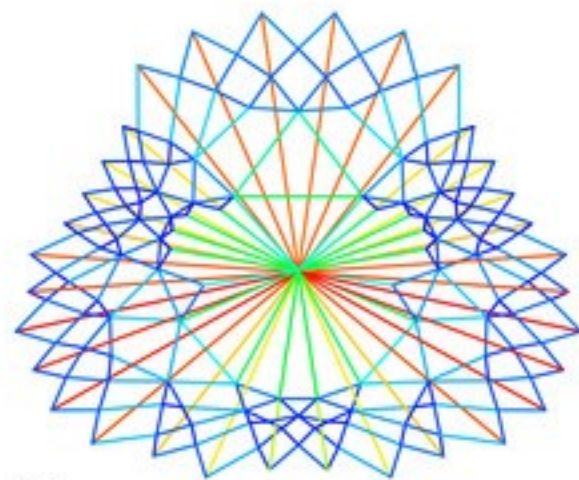




G



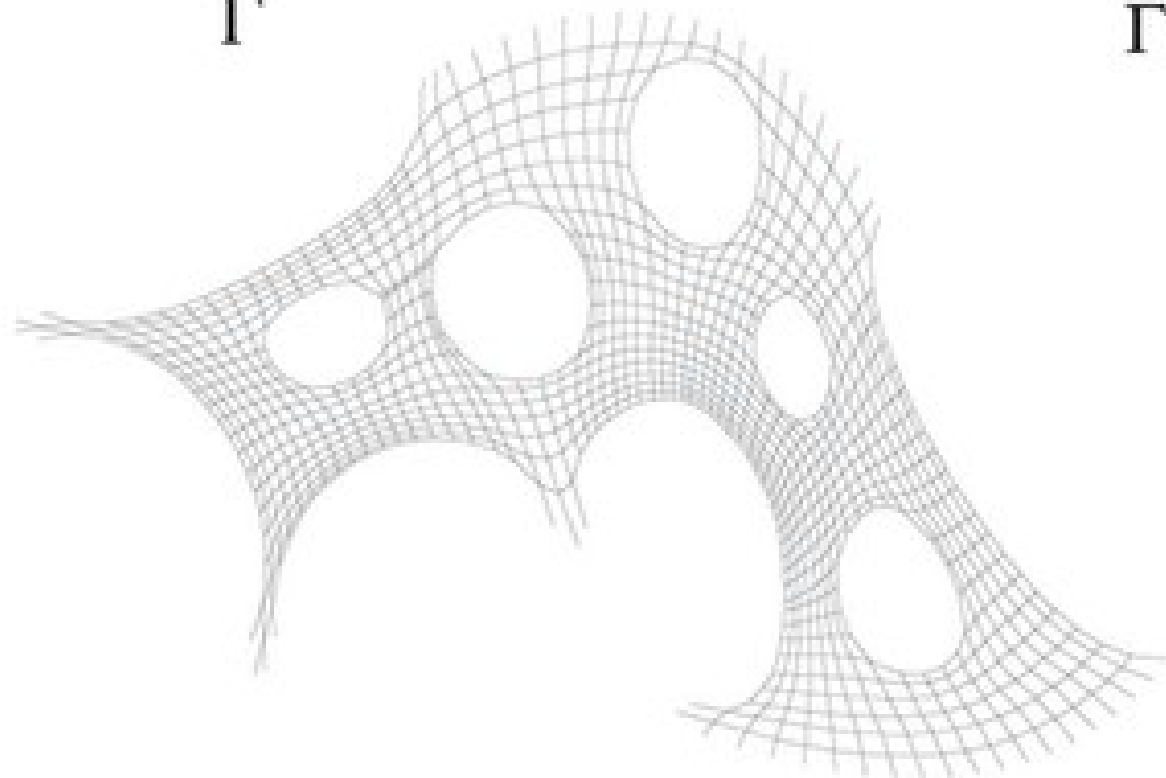
Γ



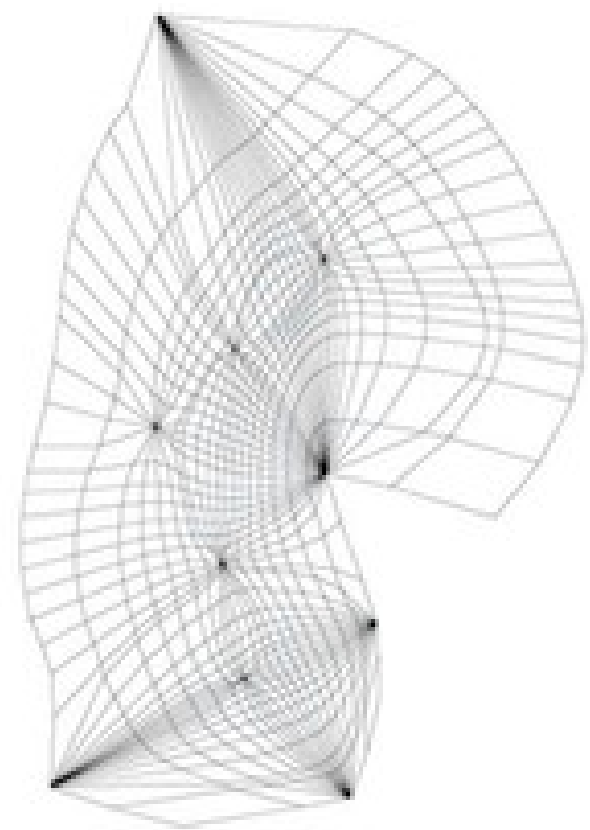
Γ^*



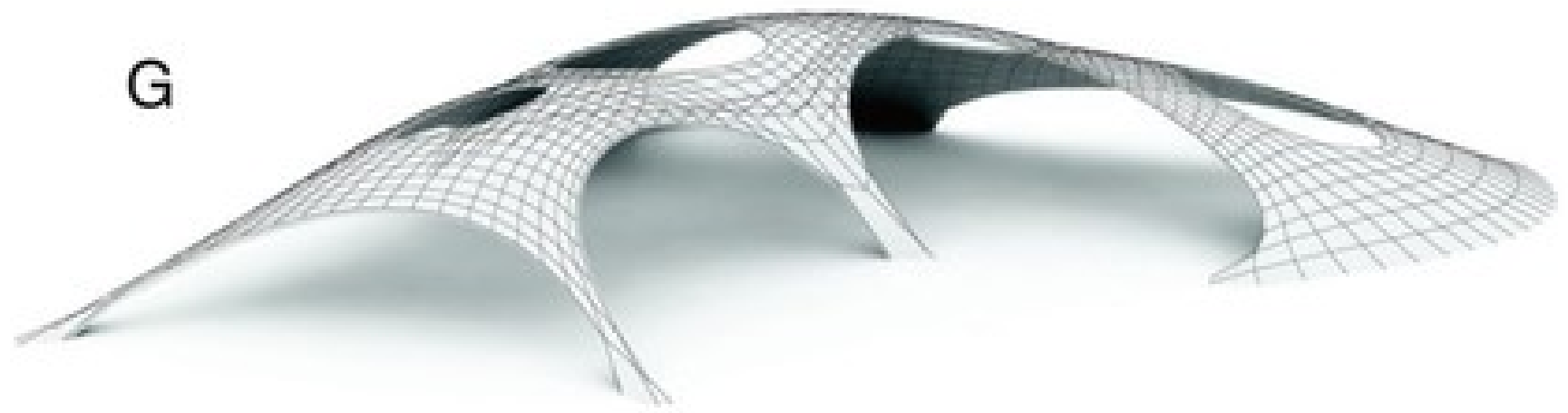
Γ

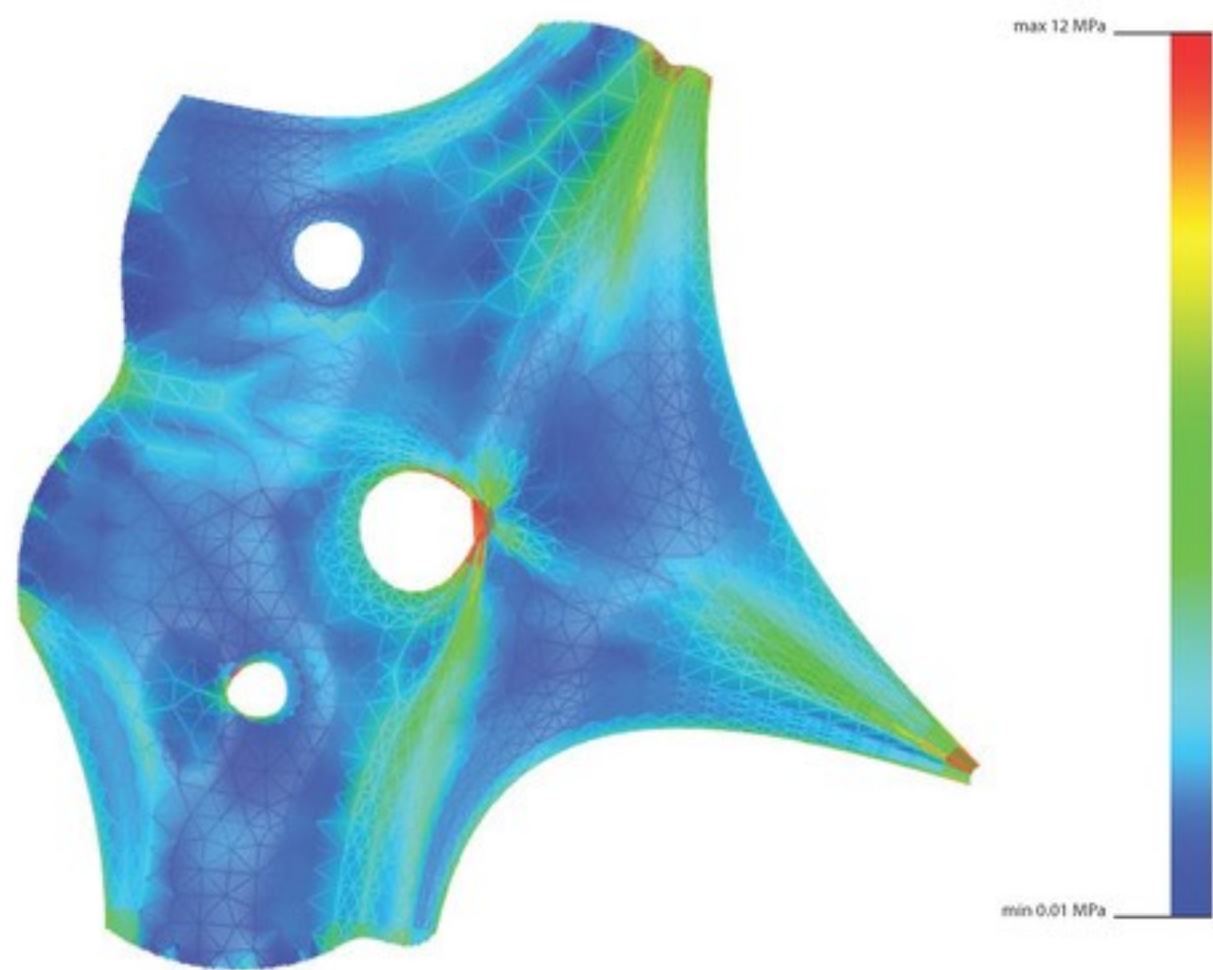
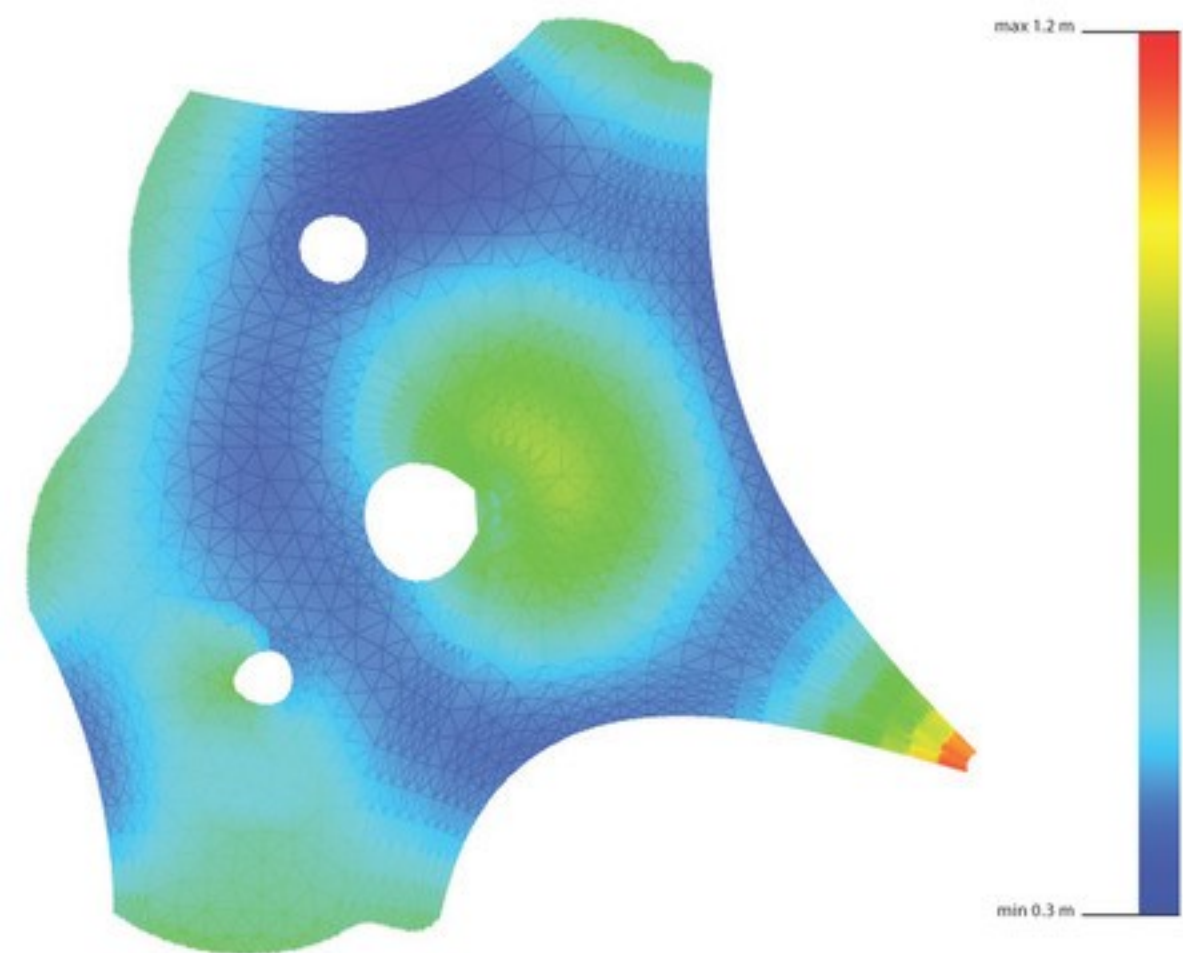


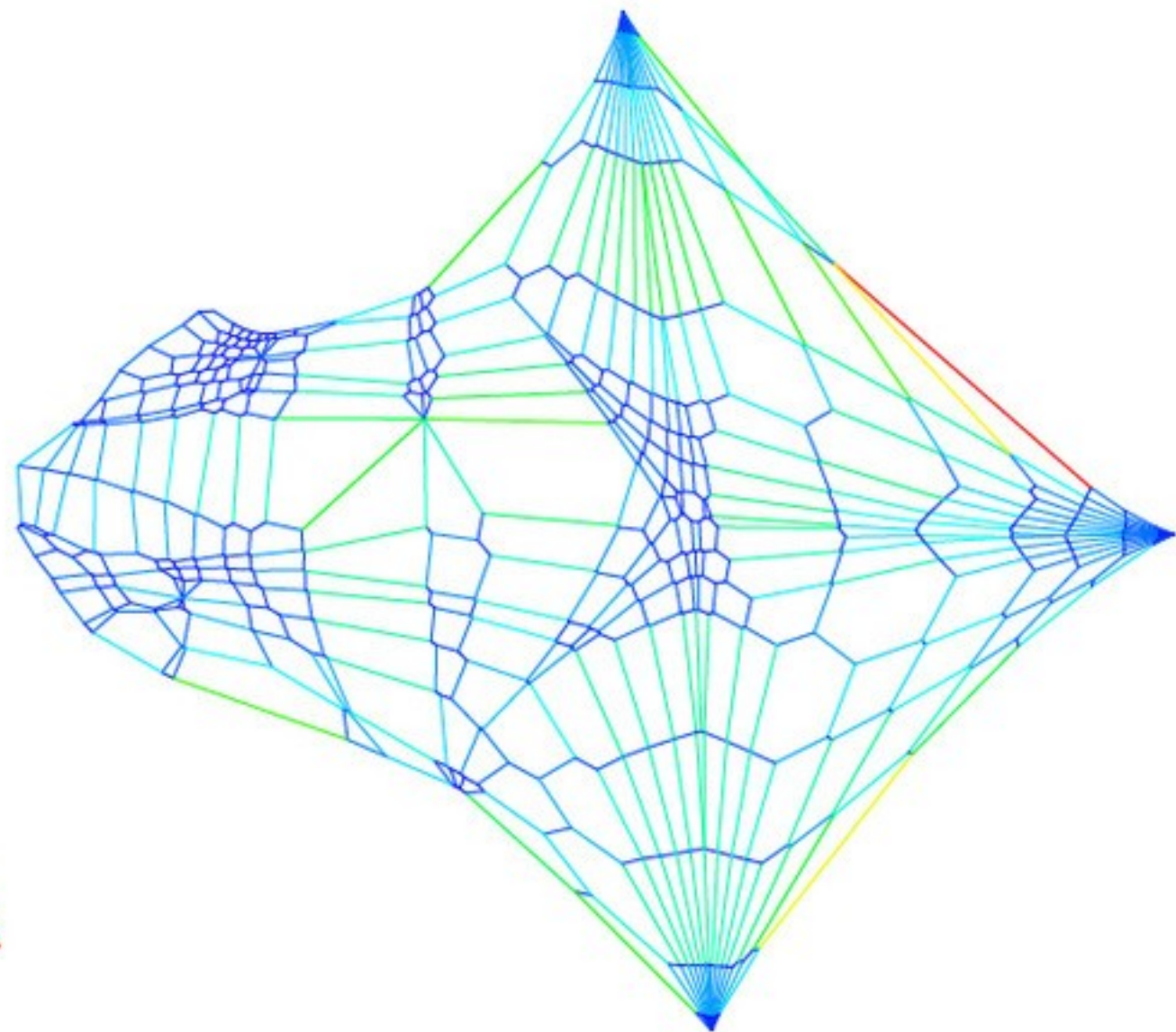
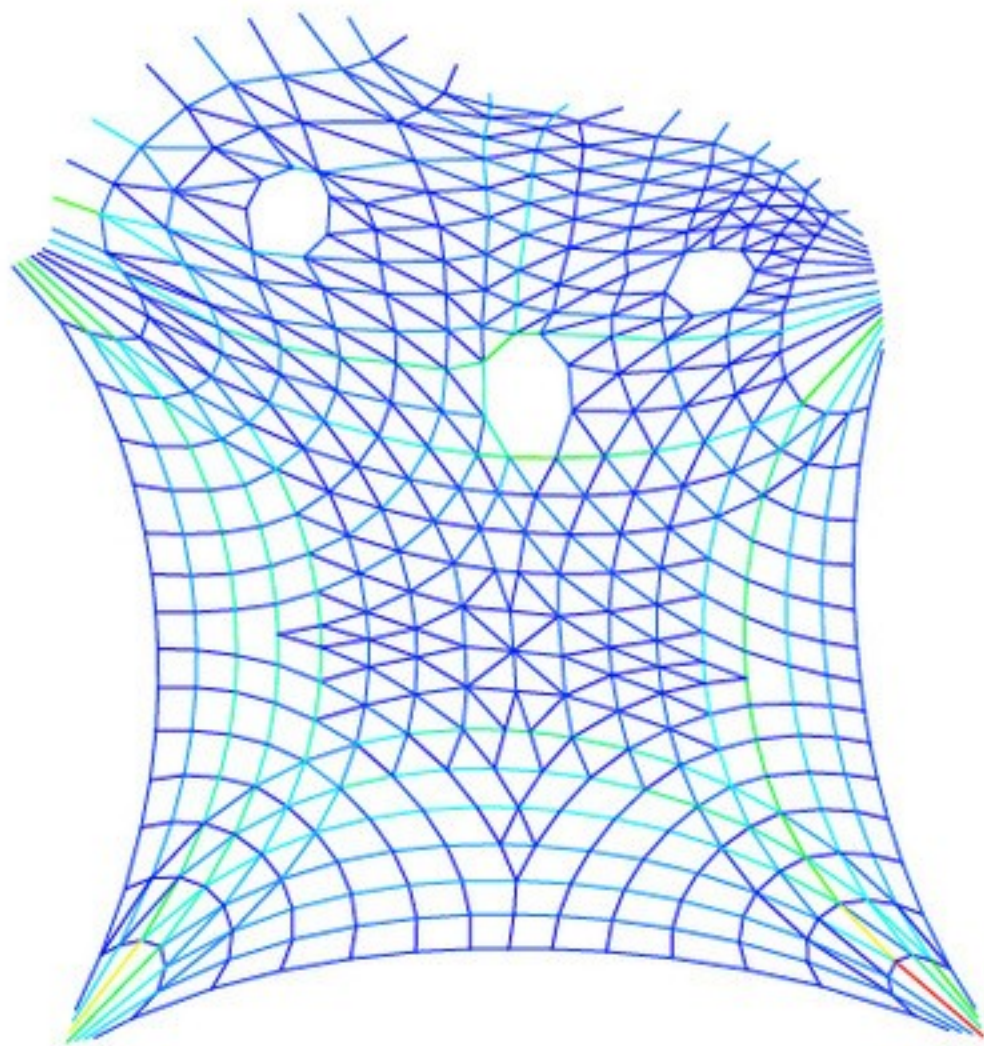
Γ^*

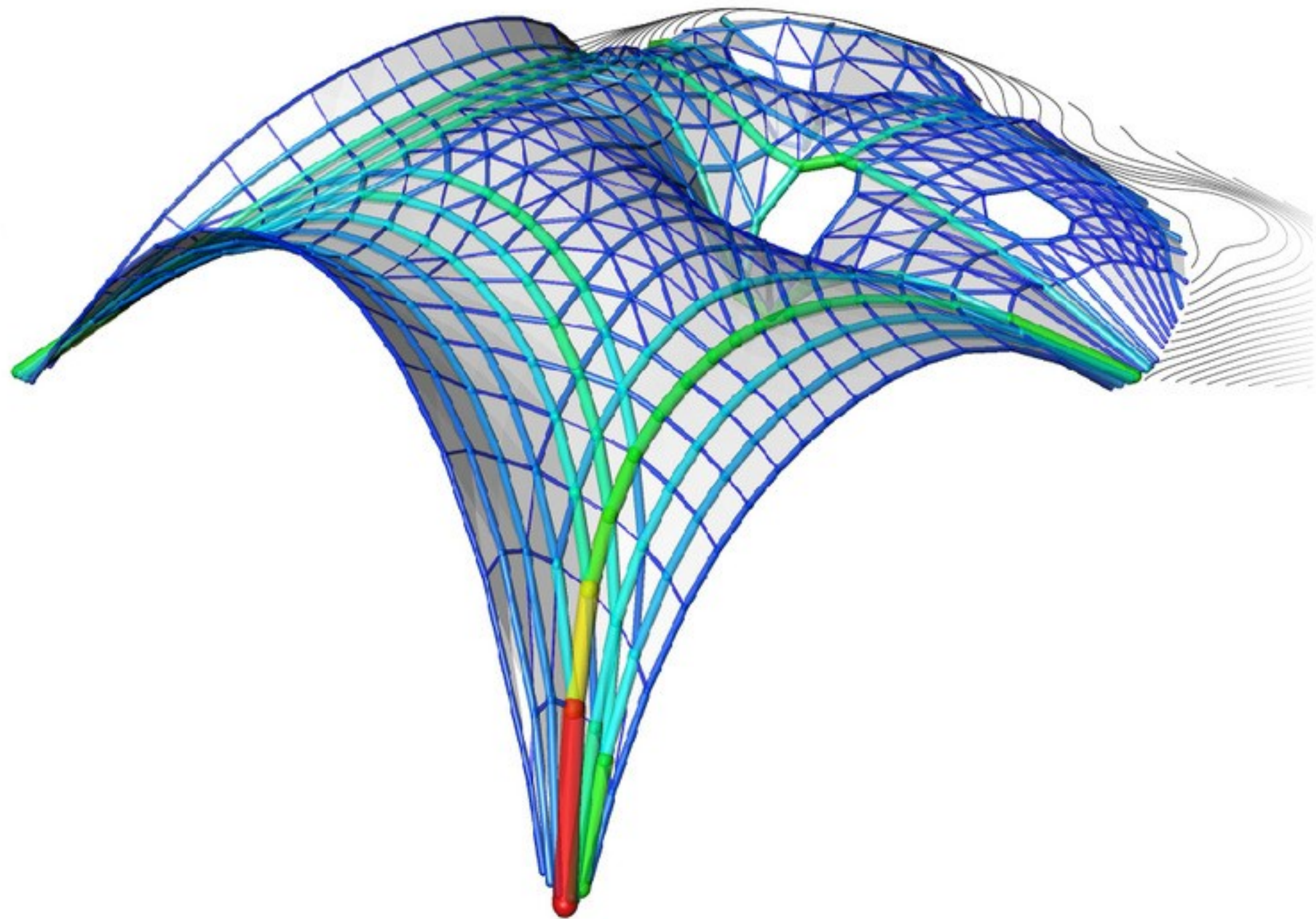


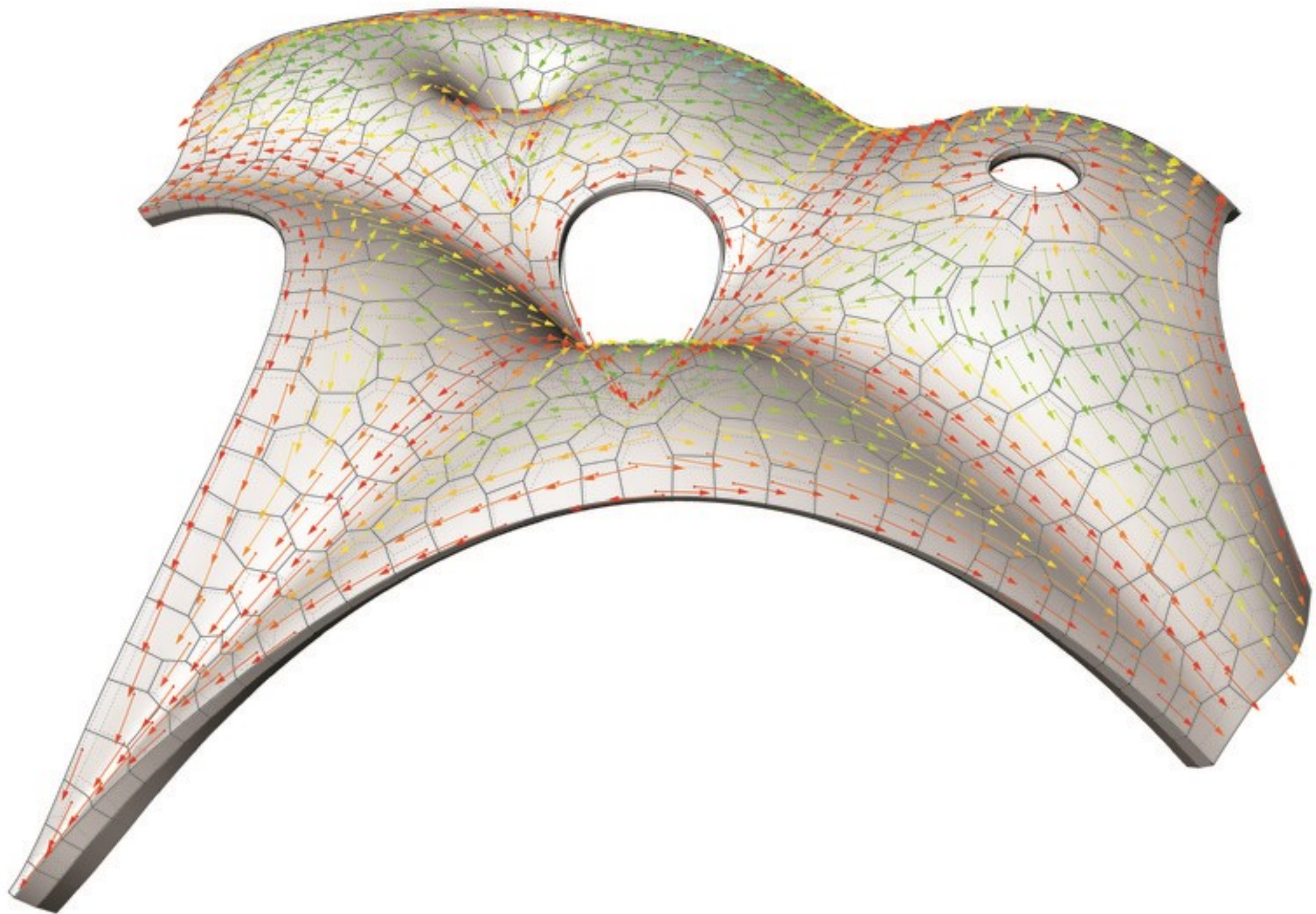
G

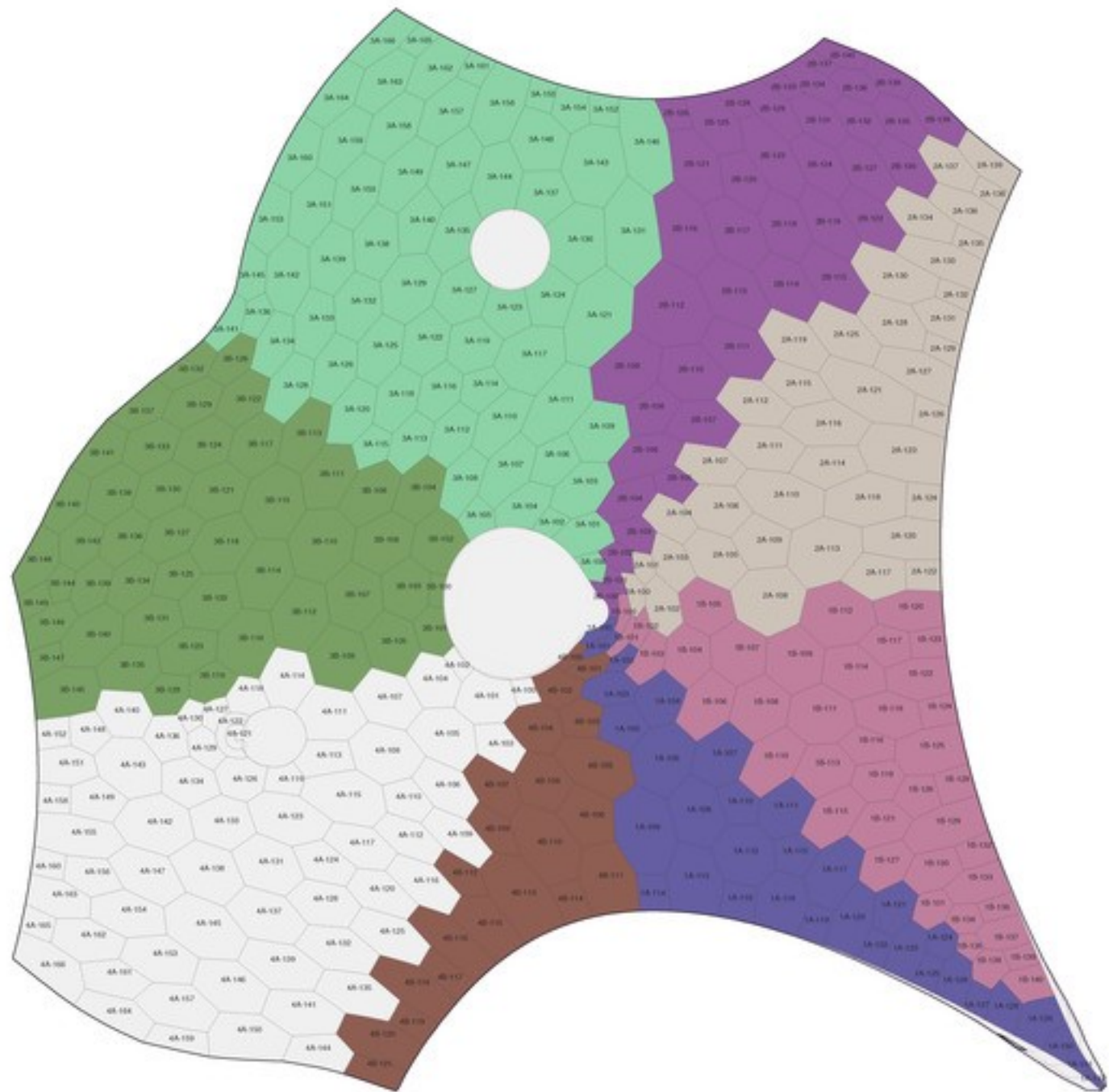
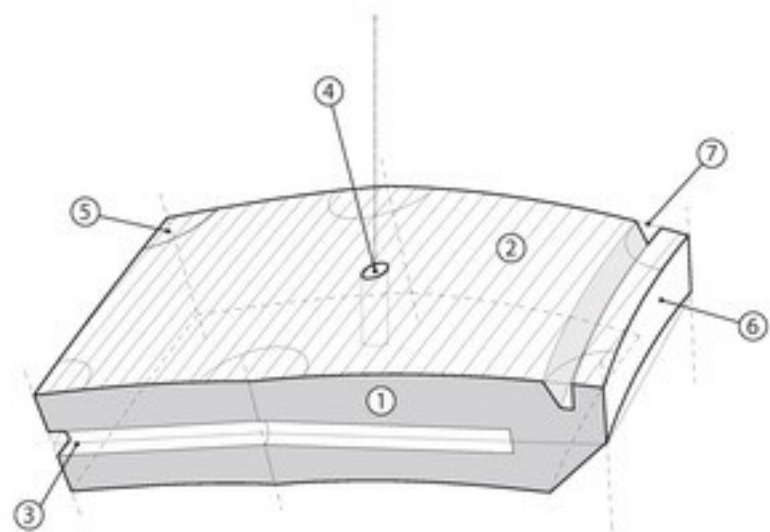
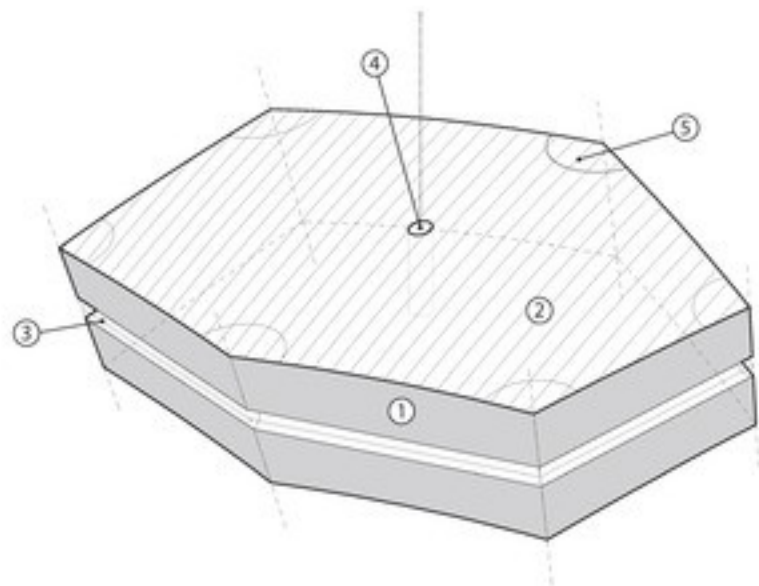




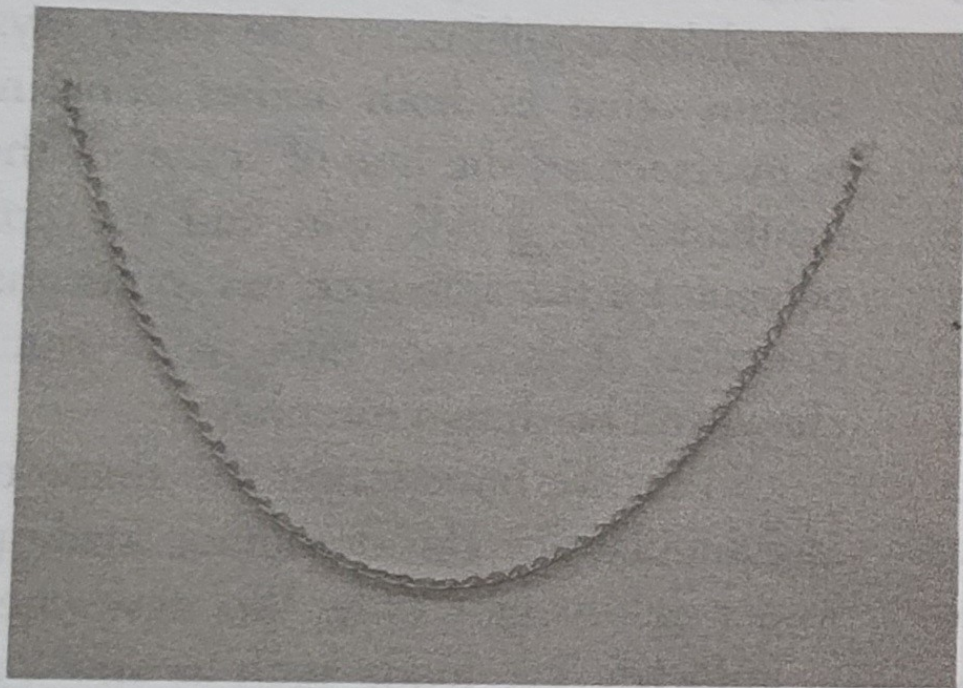




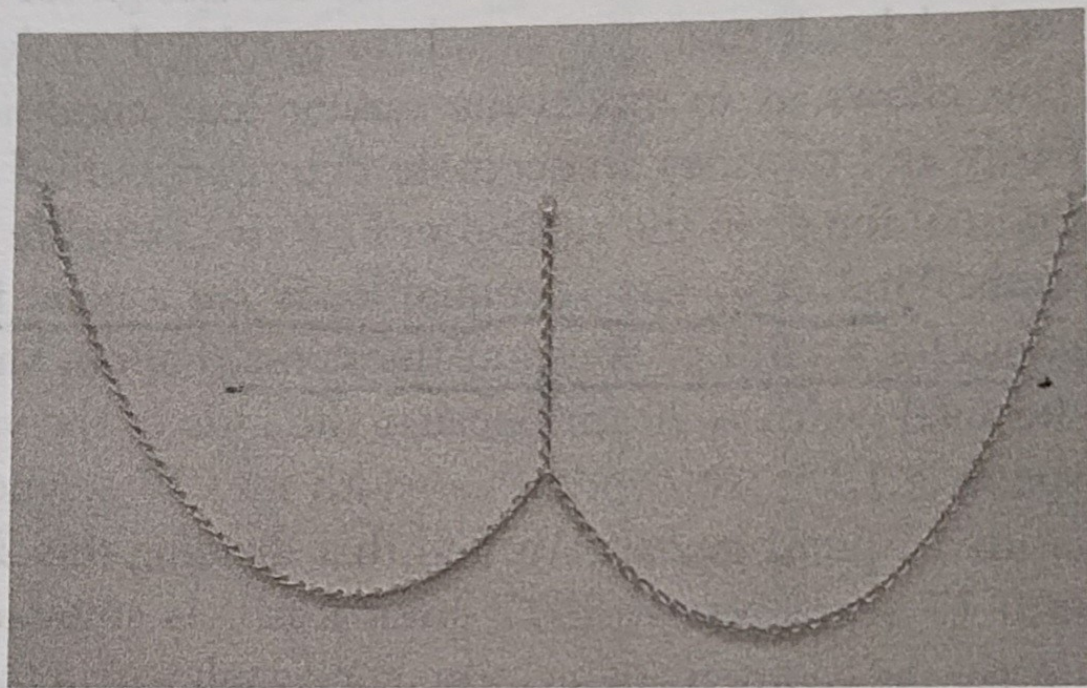




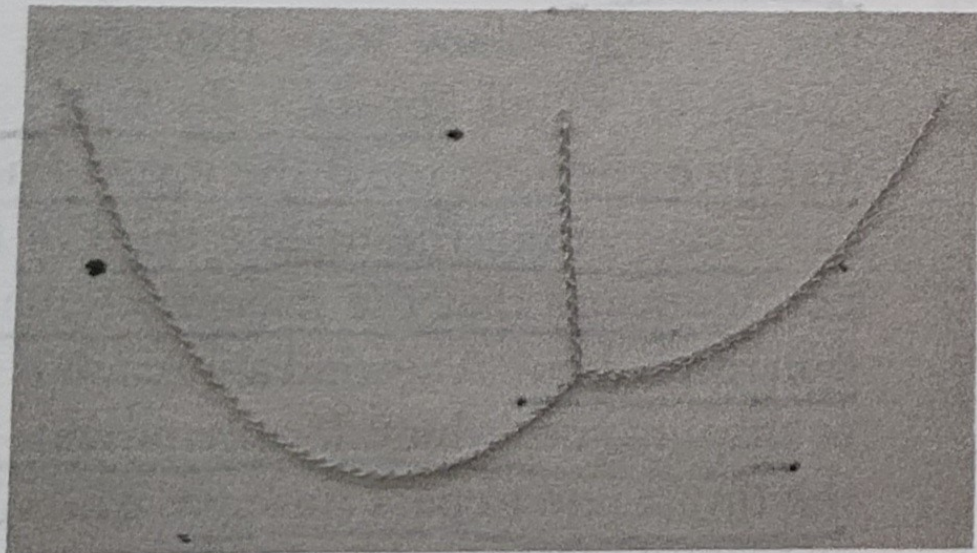




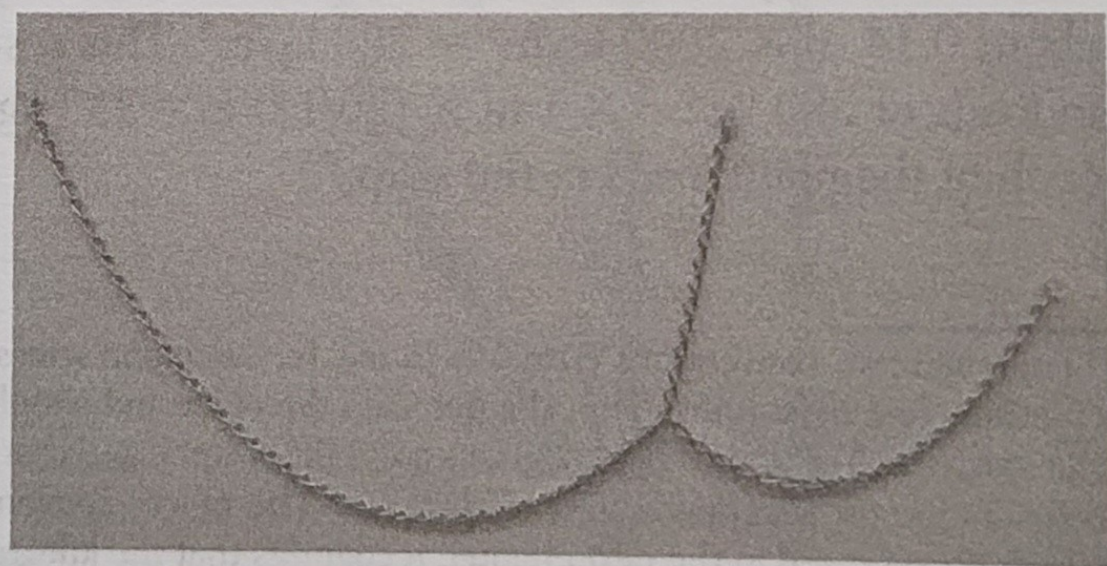
(a)



(b)



(c)



(d)

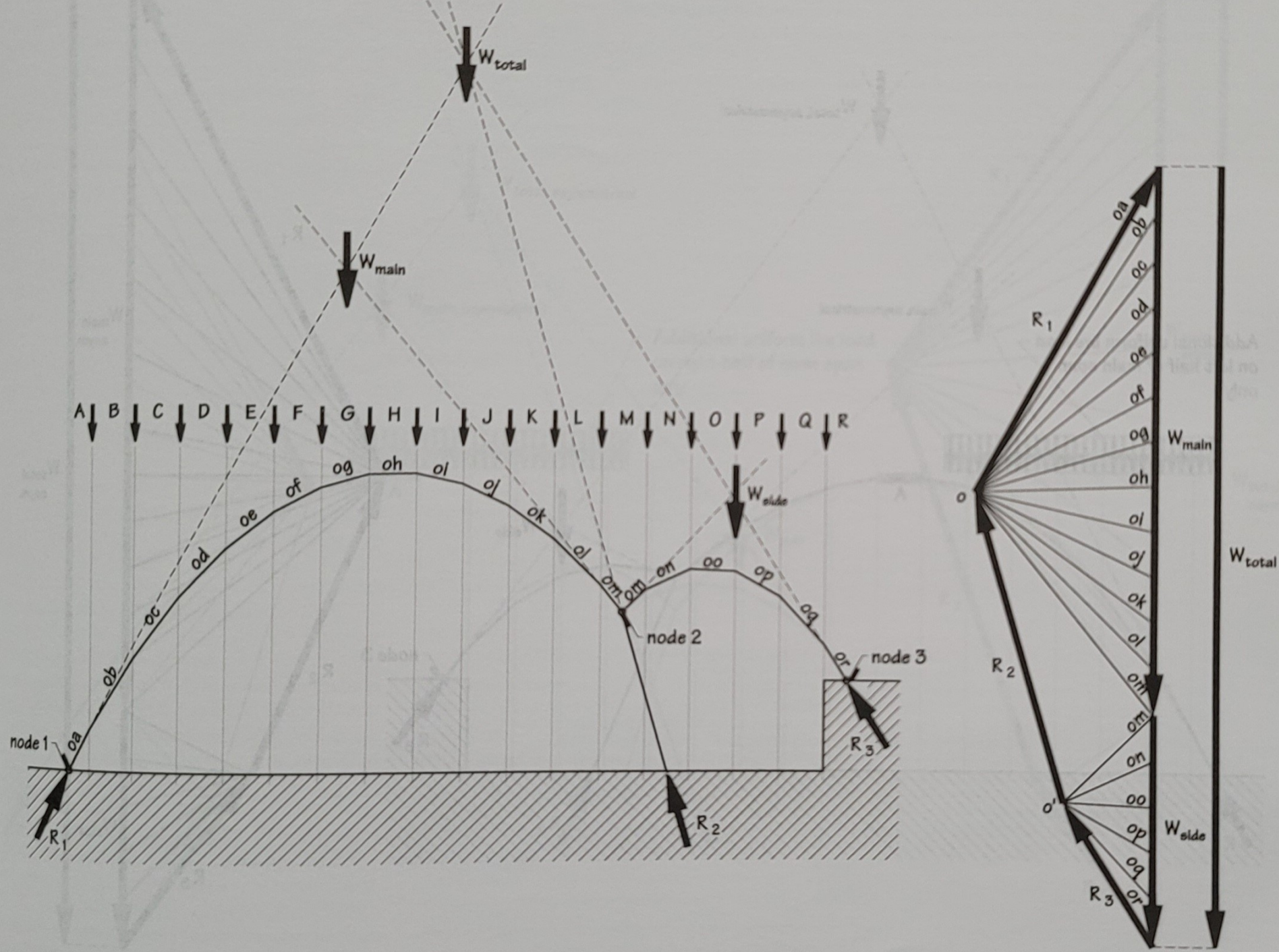
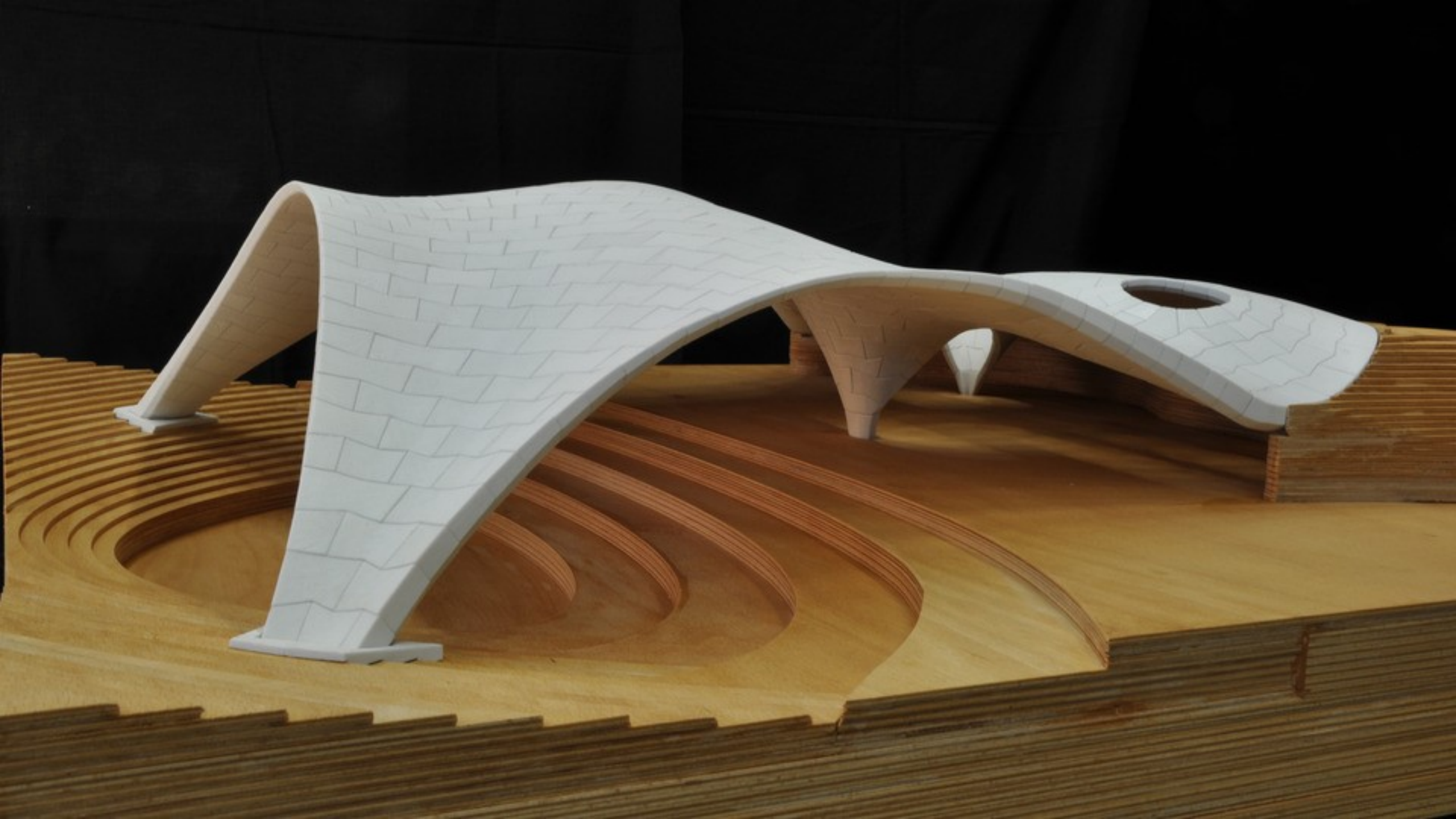
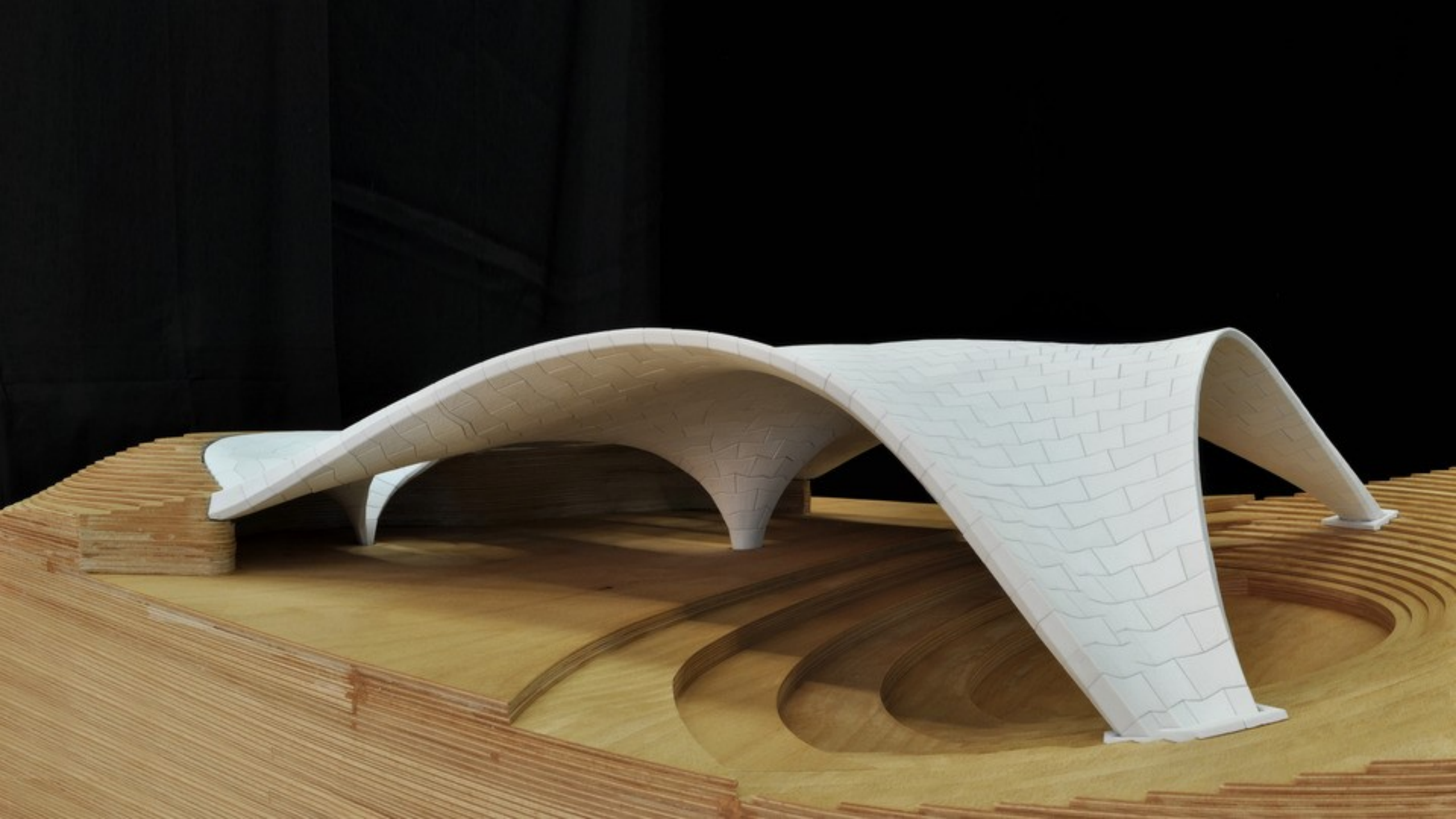
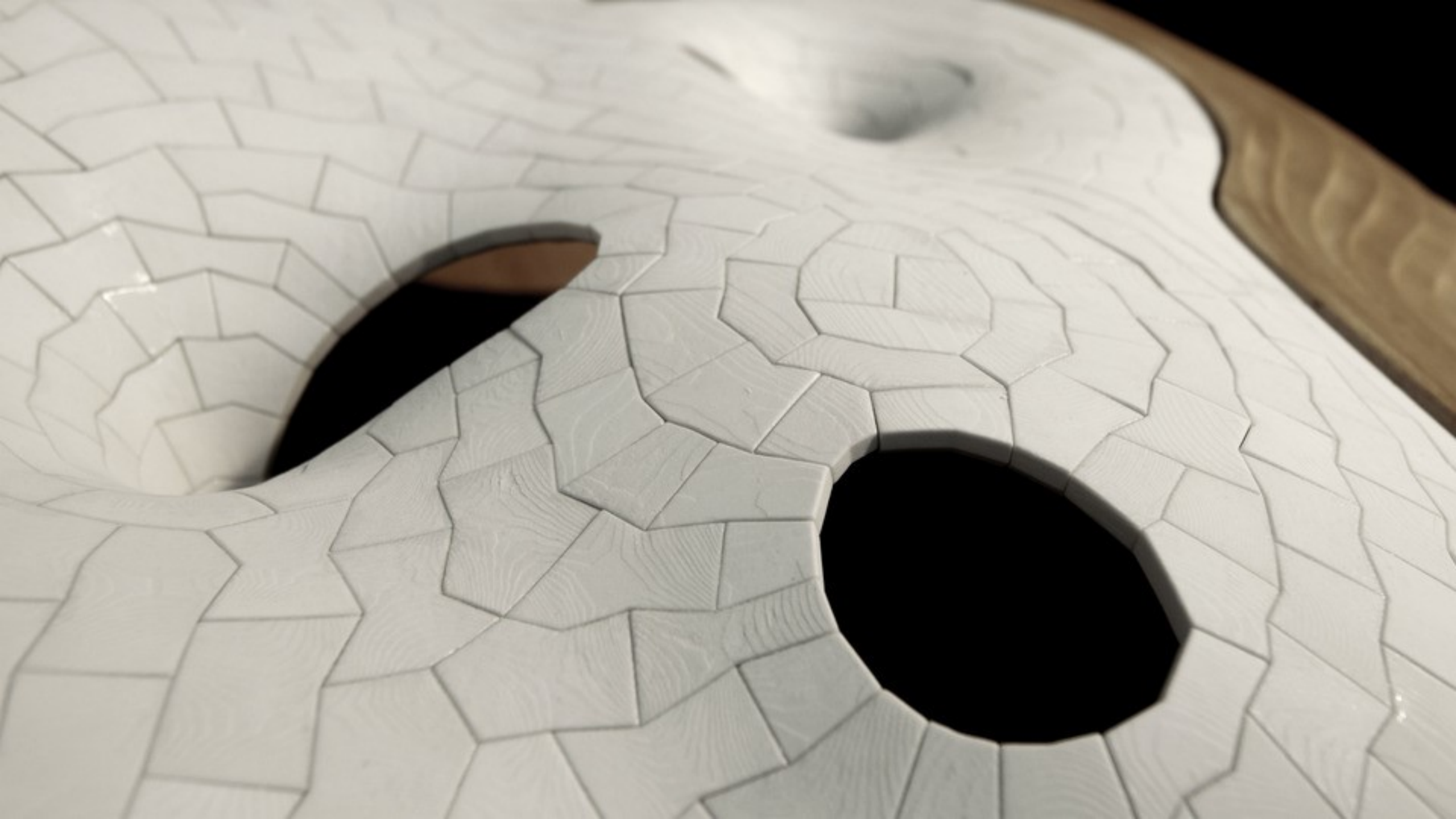


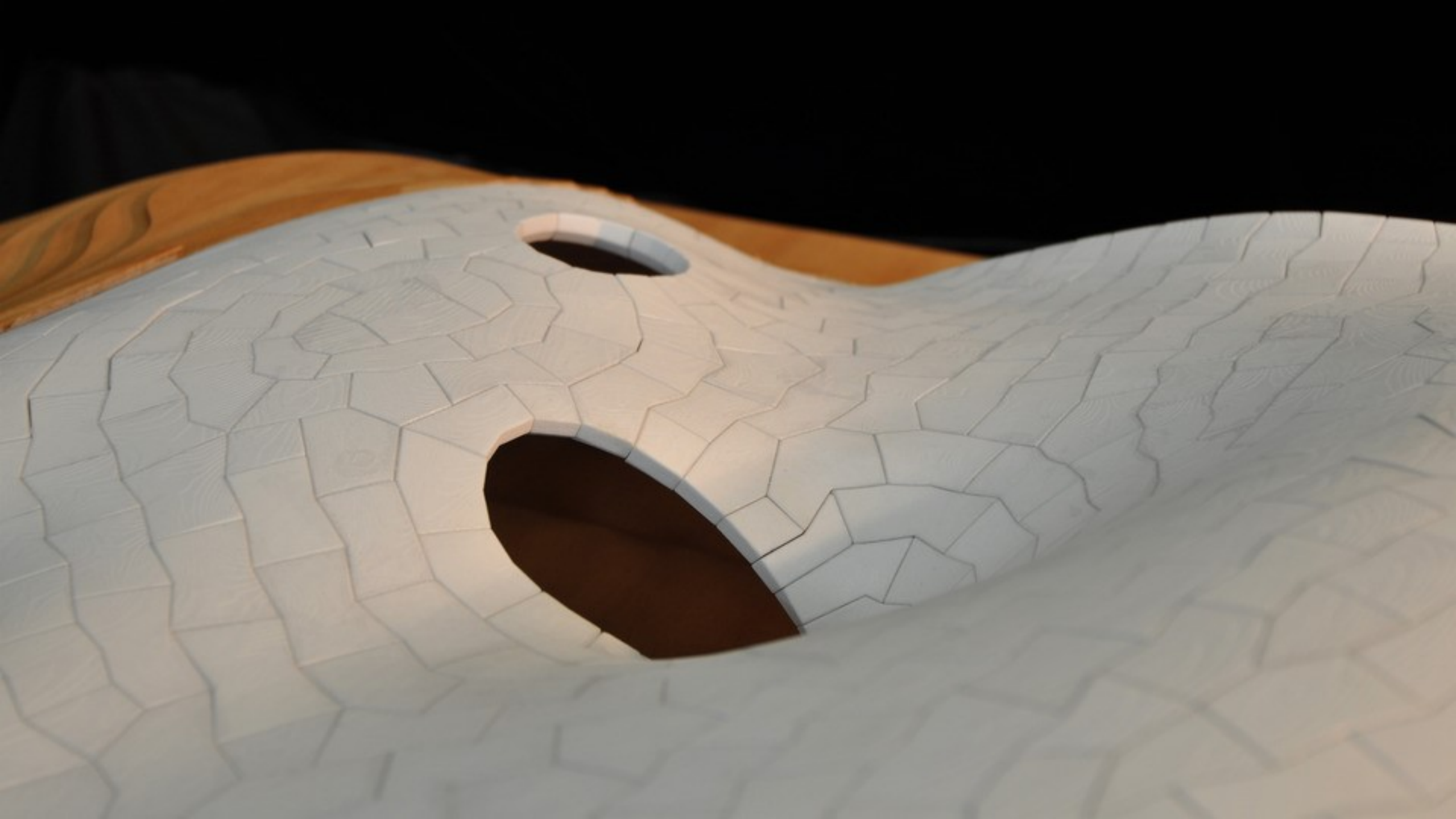
Figure 2.2.1. Decomposition of total weight into main weight and slide weight.



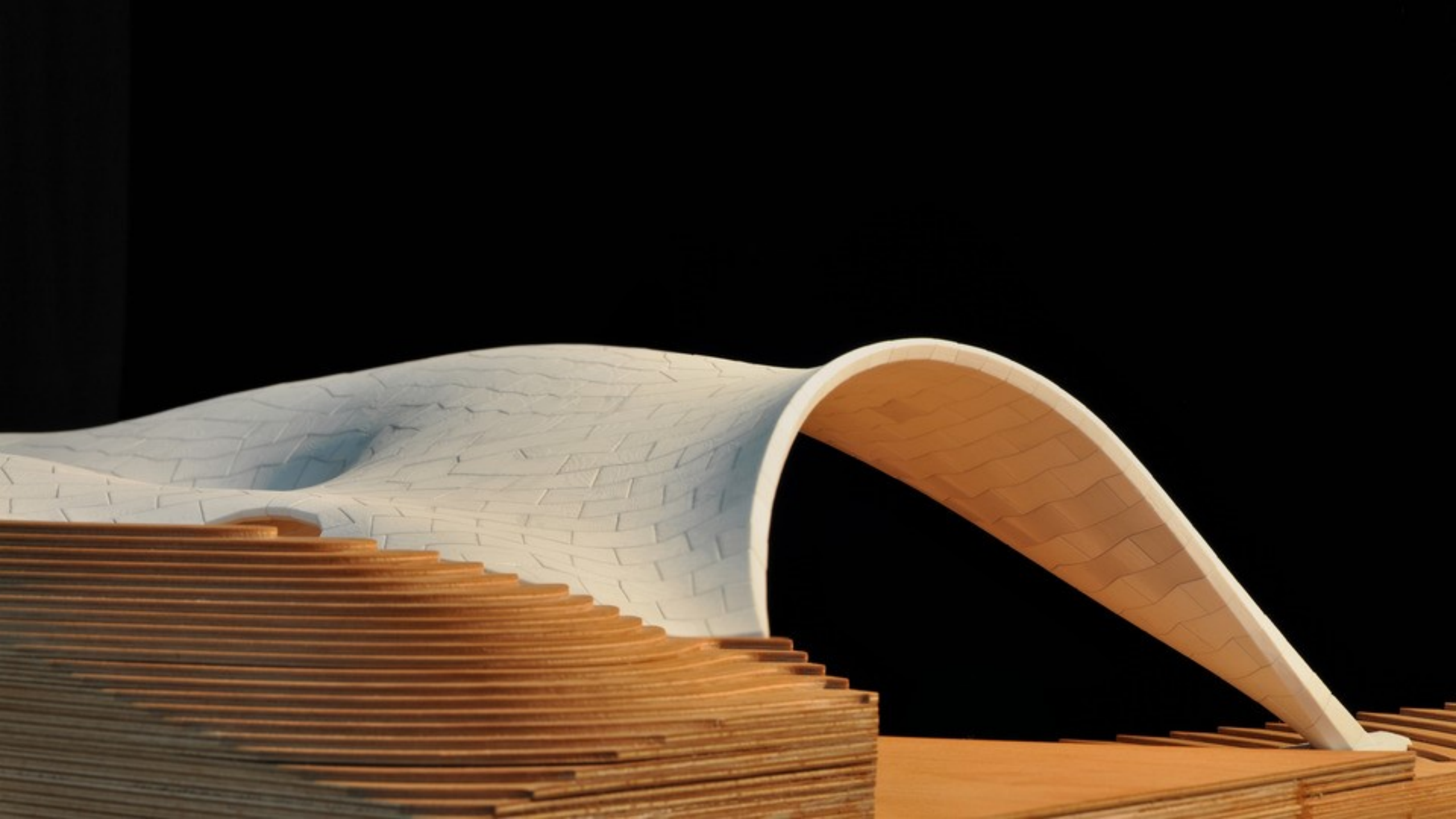




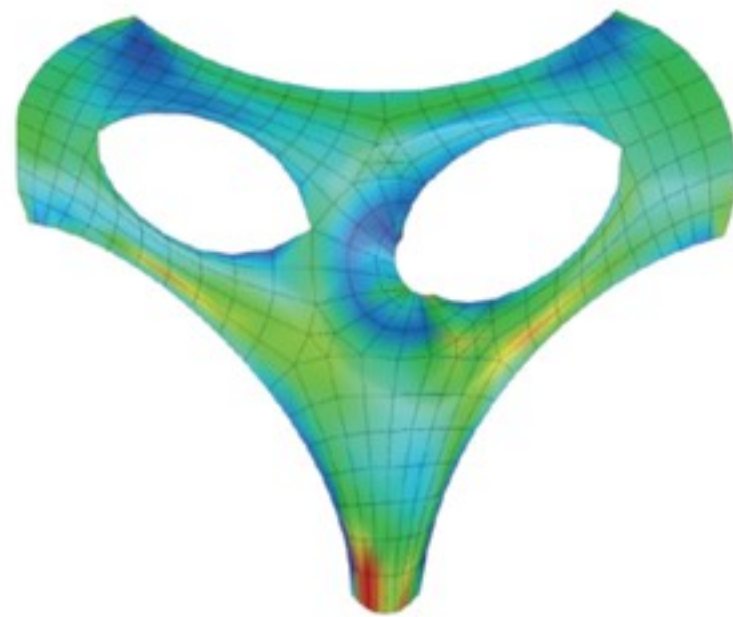
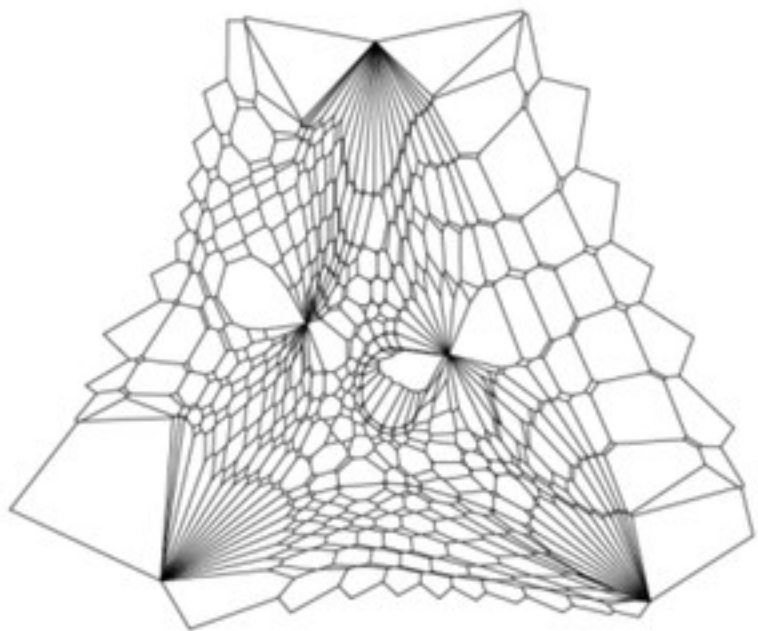












0.006 MPa

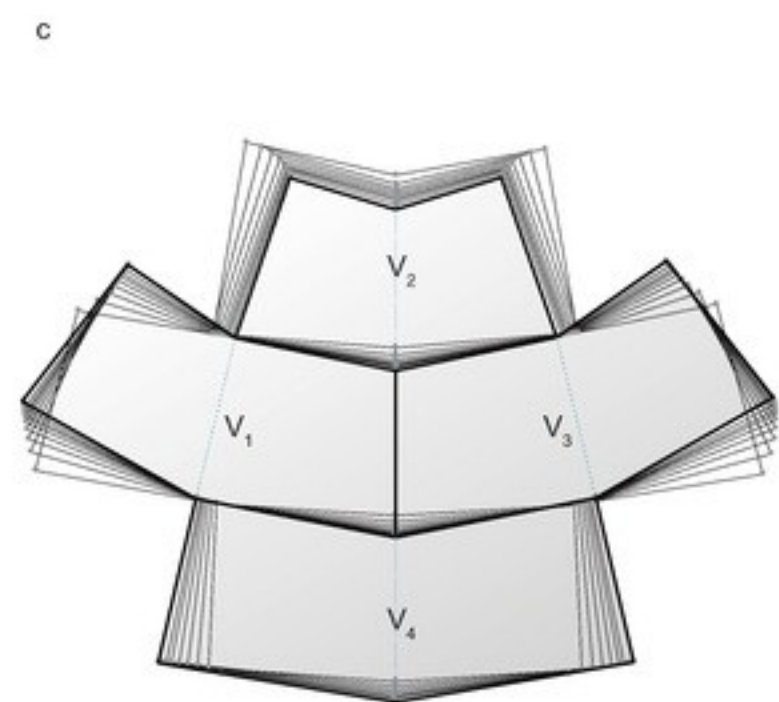
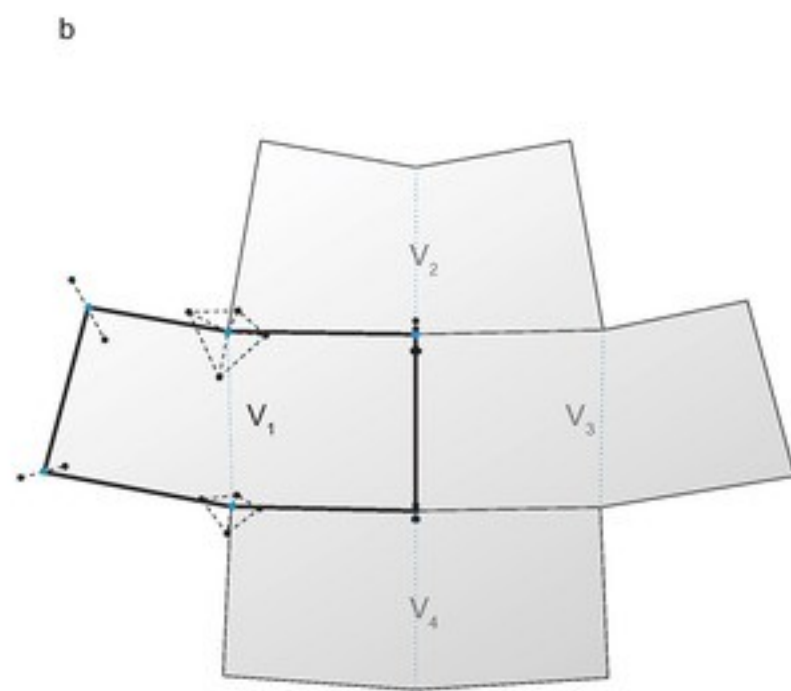
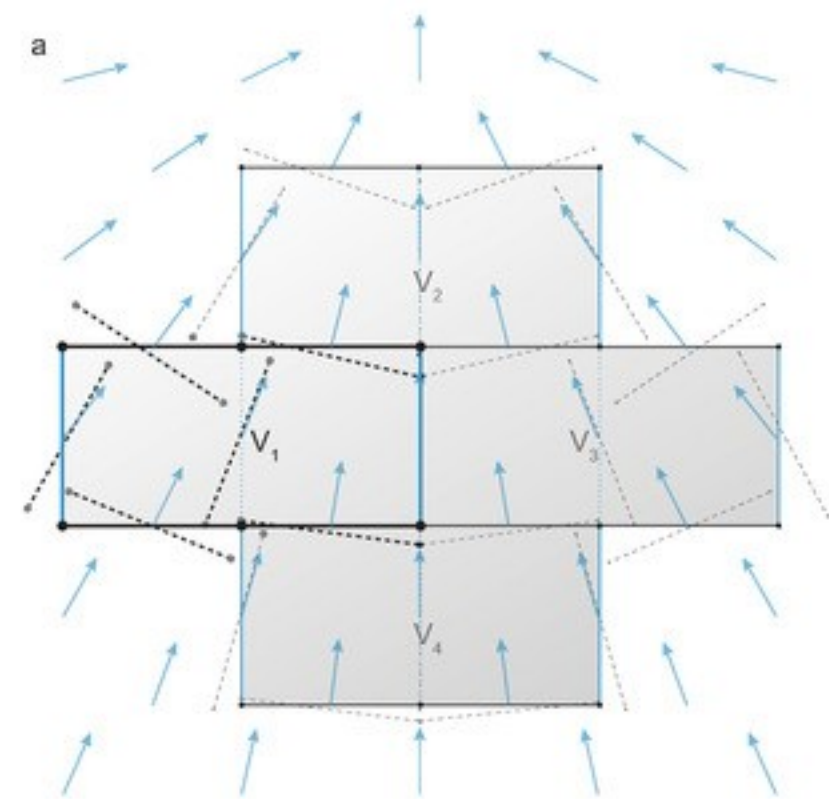


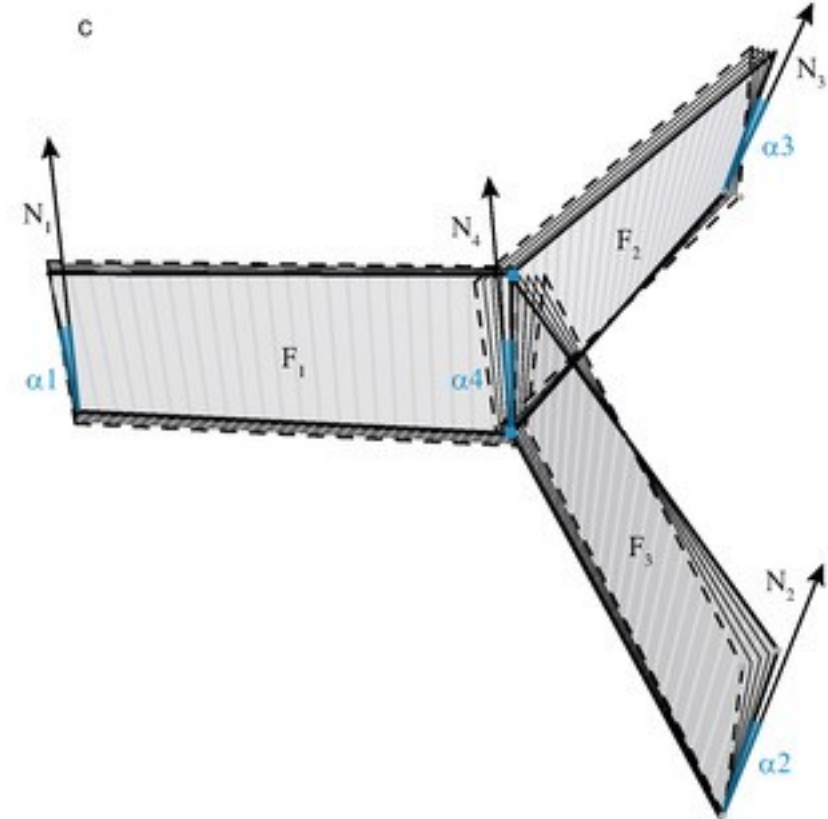
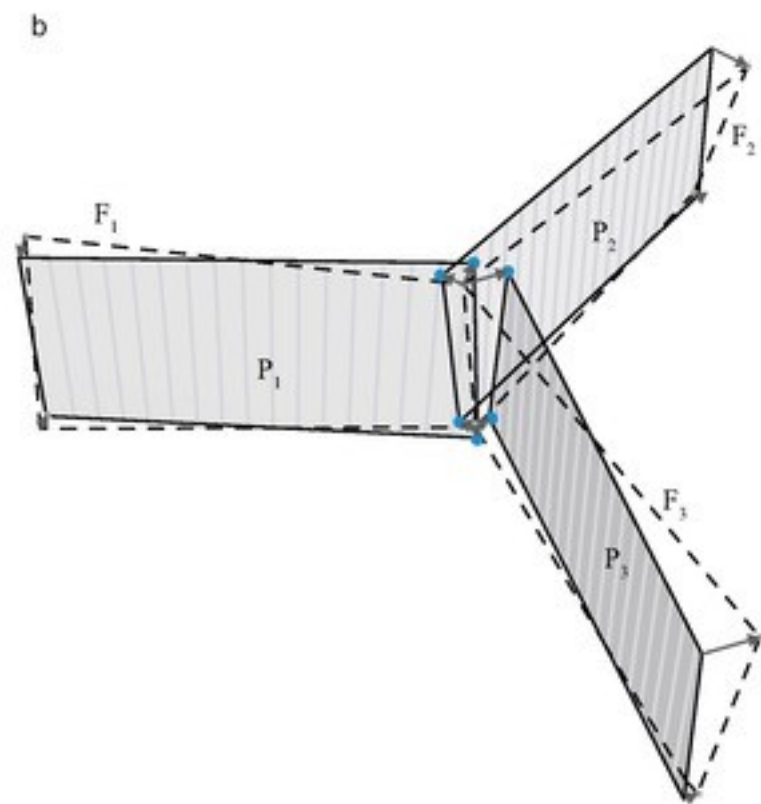
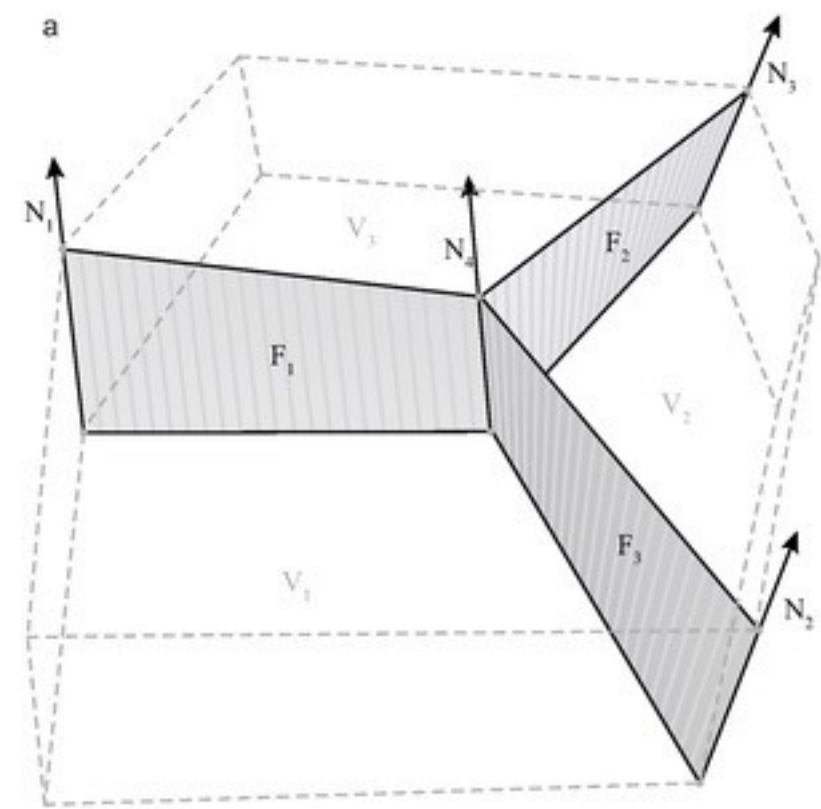
0.096 MPa

































NEUBAU











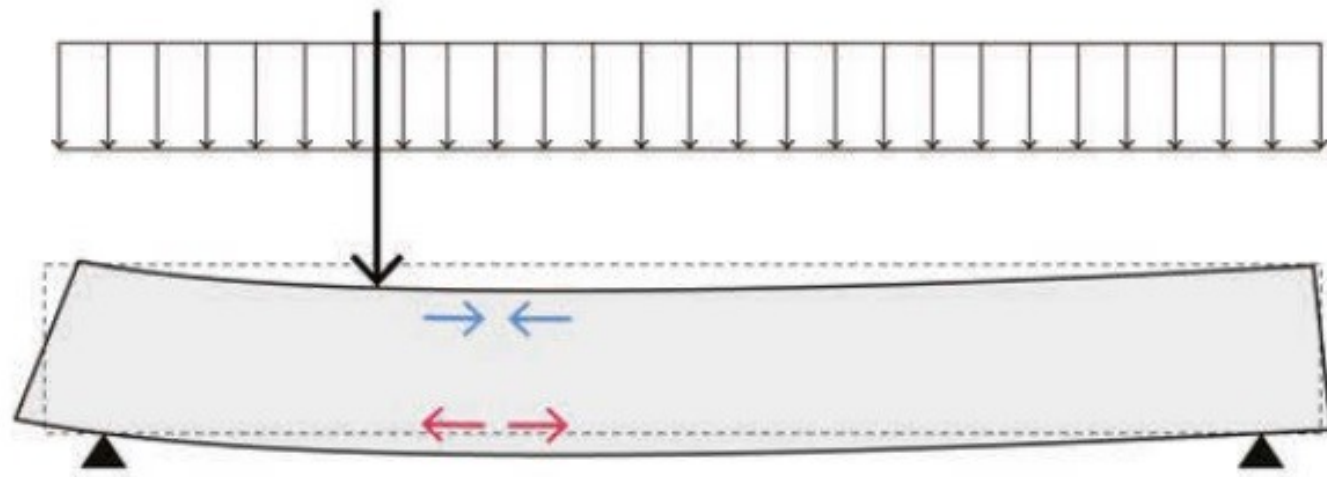




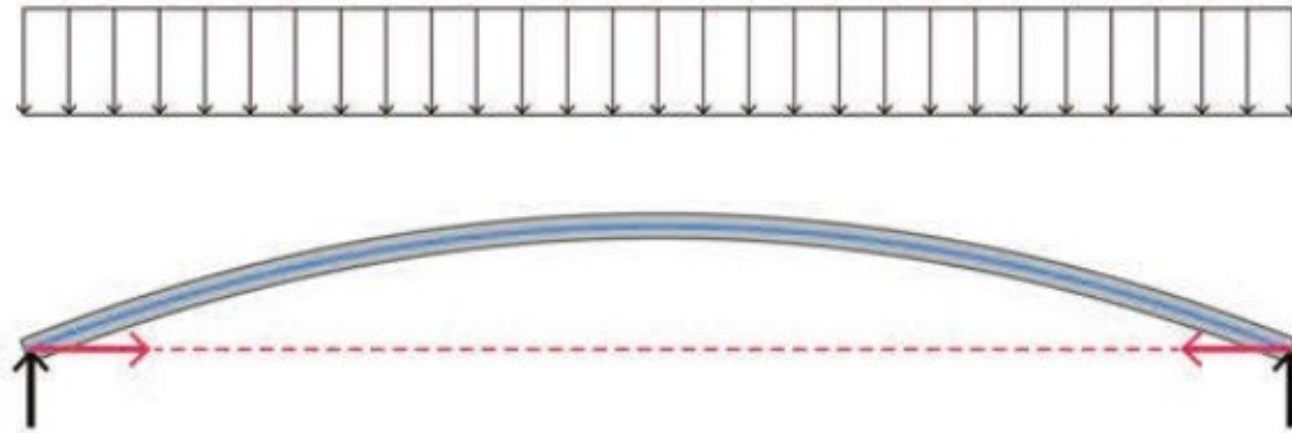




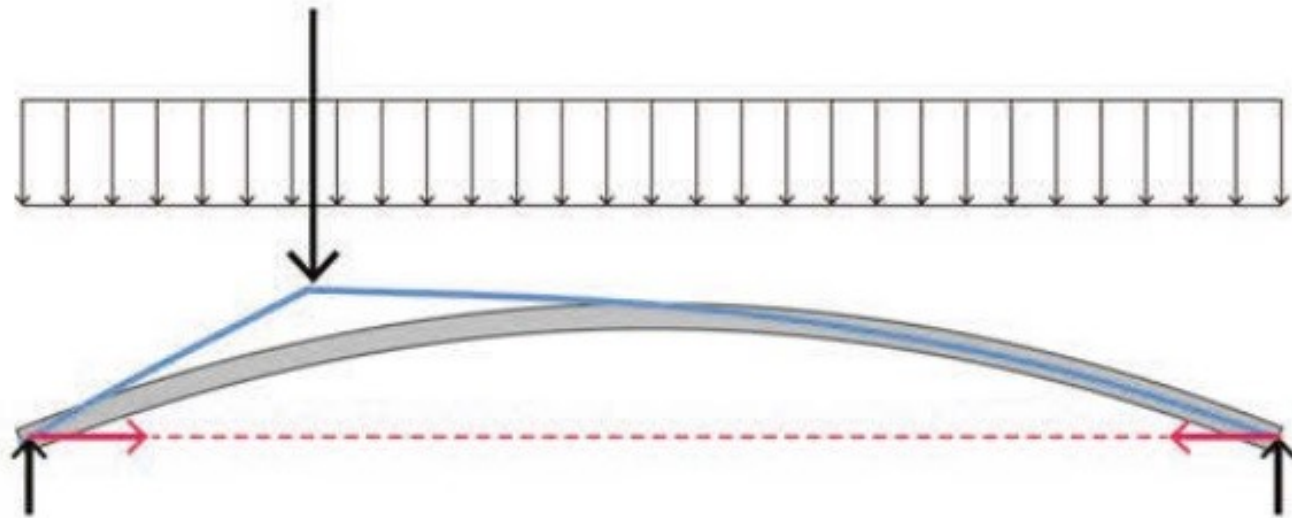




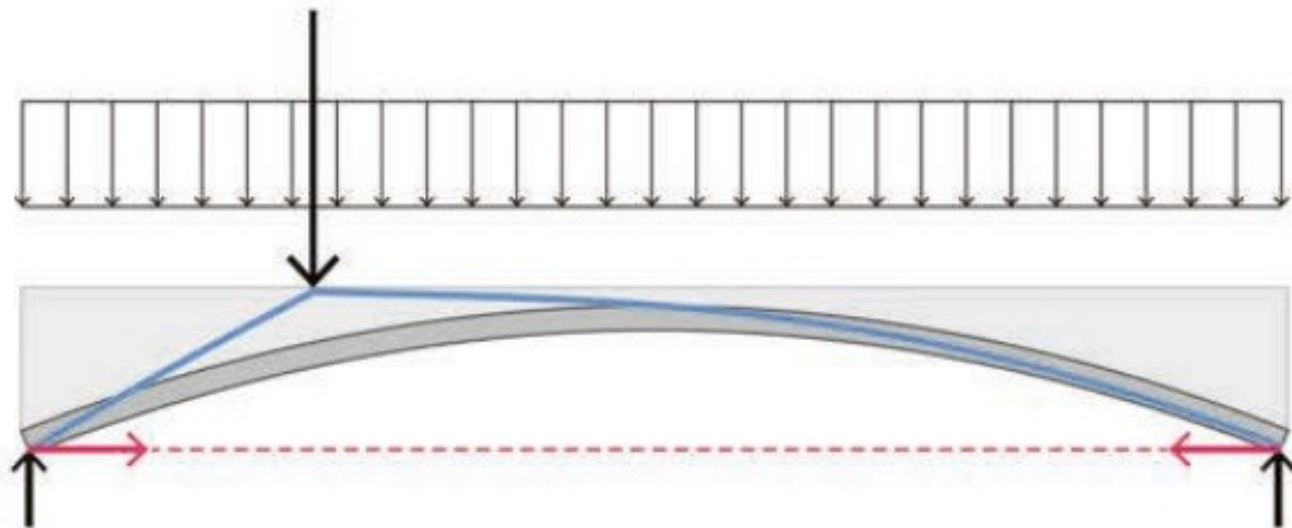
i) Standard concrete element resisting applied loads through bending action



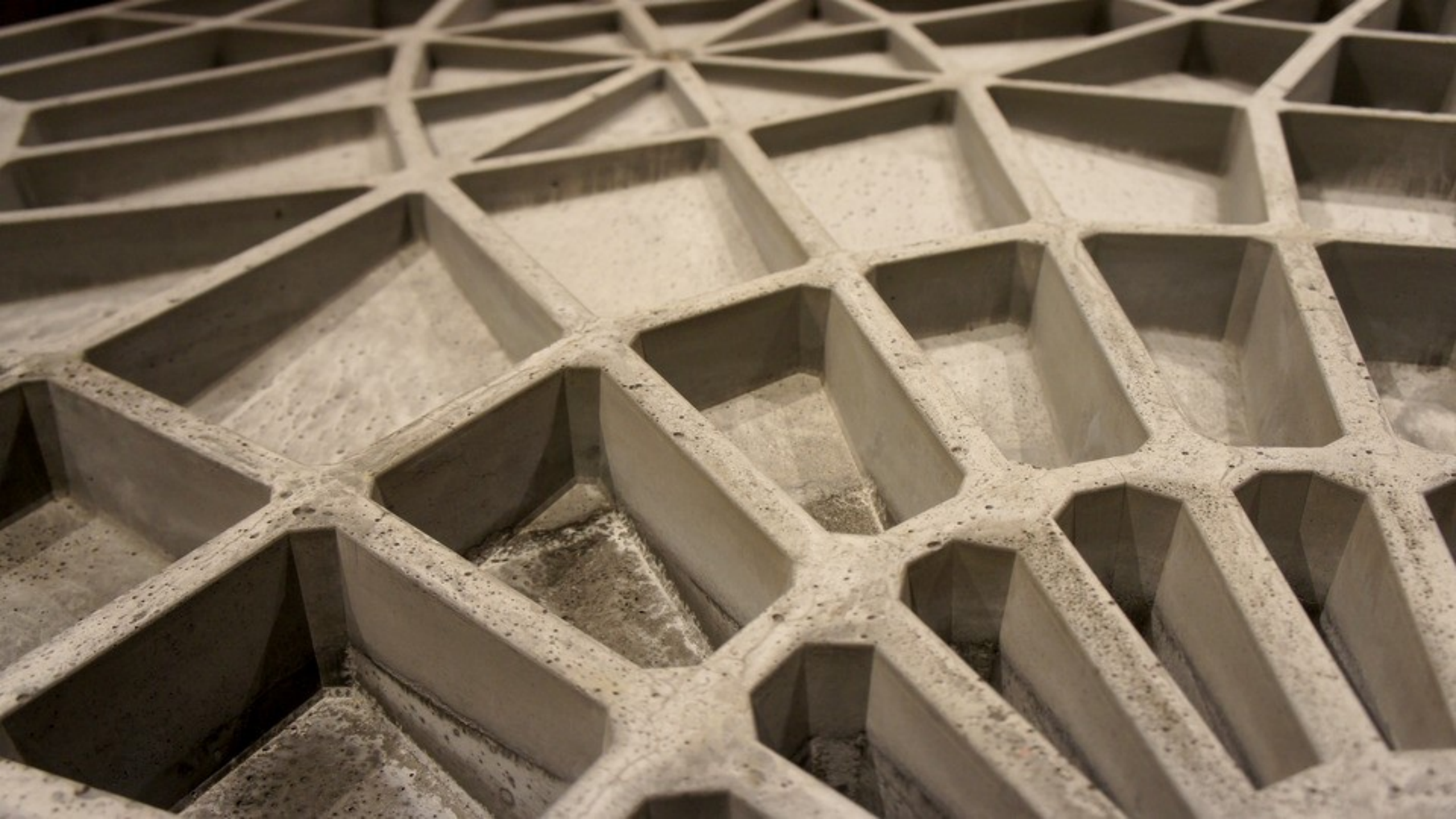
ii) Same load is resisted through funicular (i.e. compression-only) action with dramatic material savings



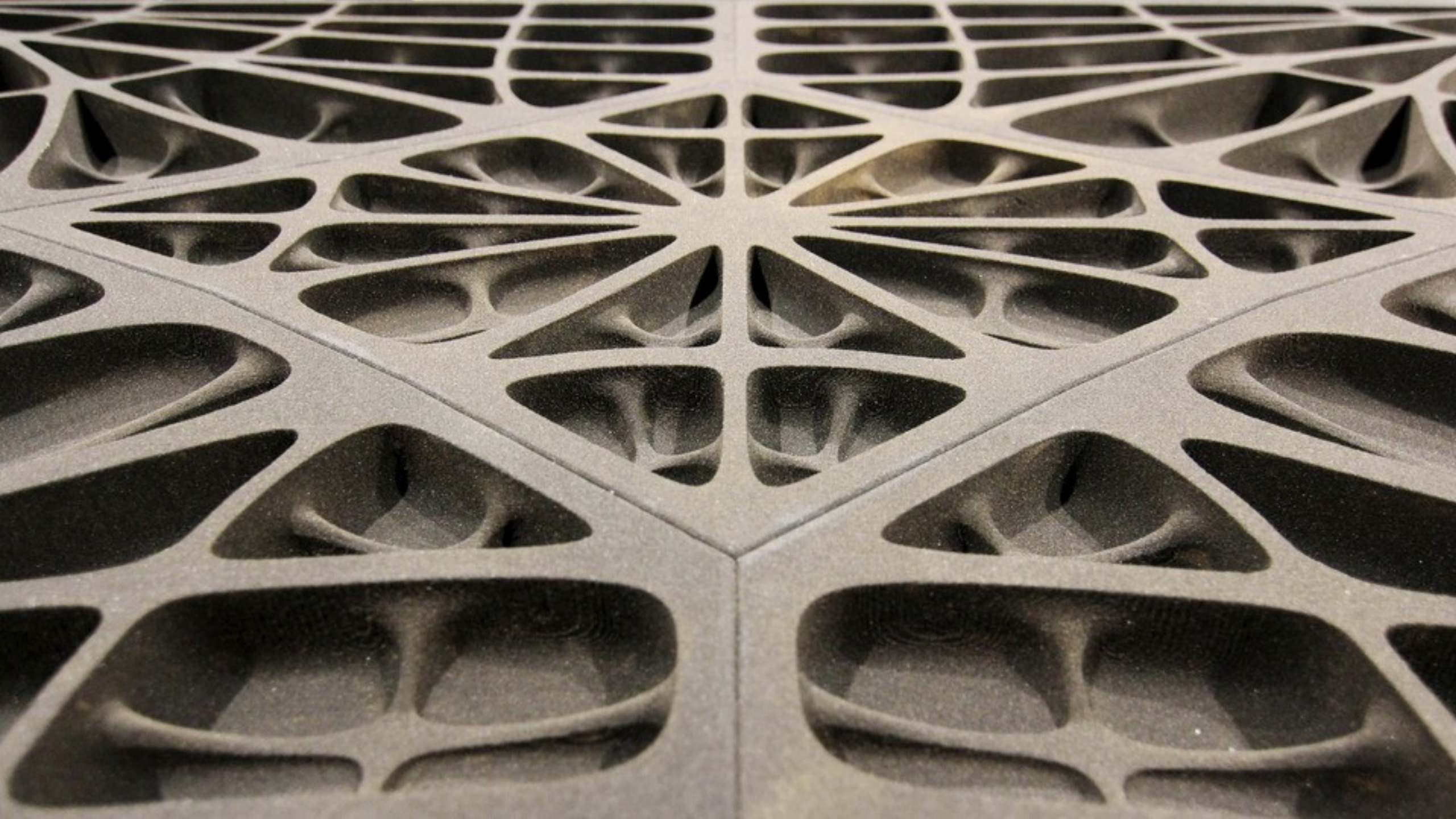
iii) Concentrated loads modify thrust line, which is now outside section of funicular element



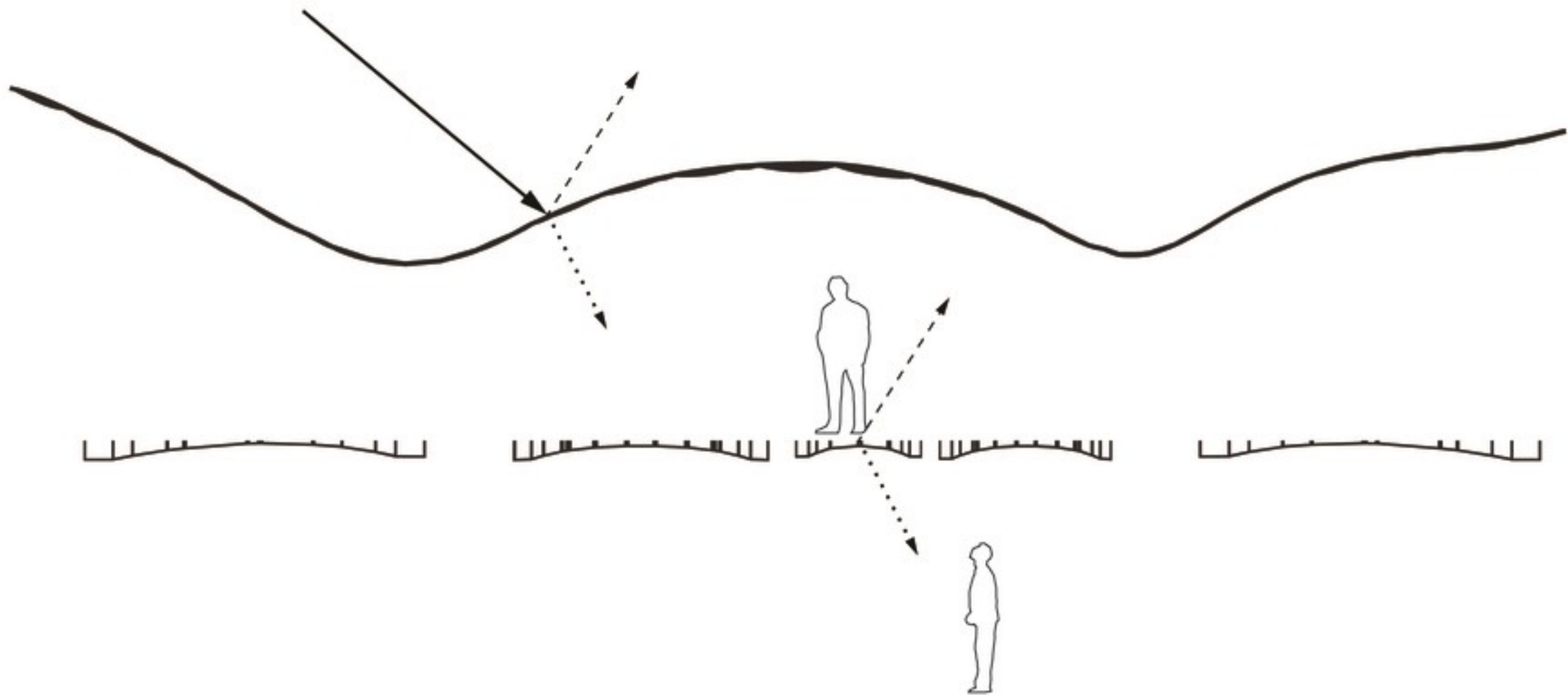
iv) Material is reintroduced (in stiffening rib) to enclose thrust line

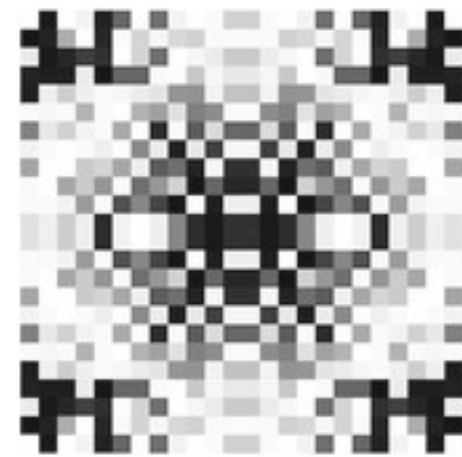
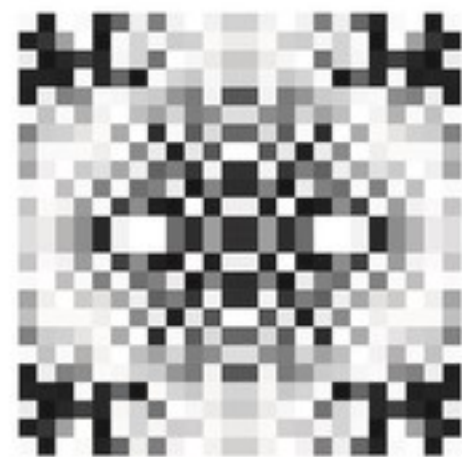
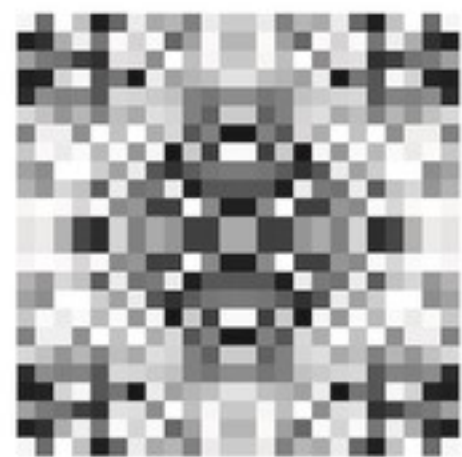
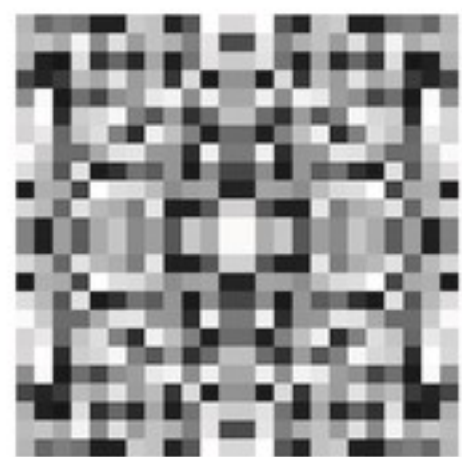


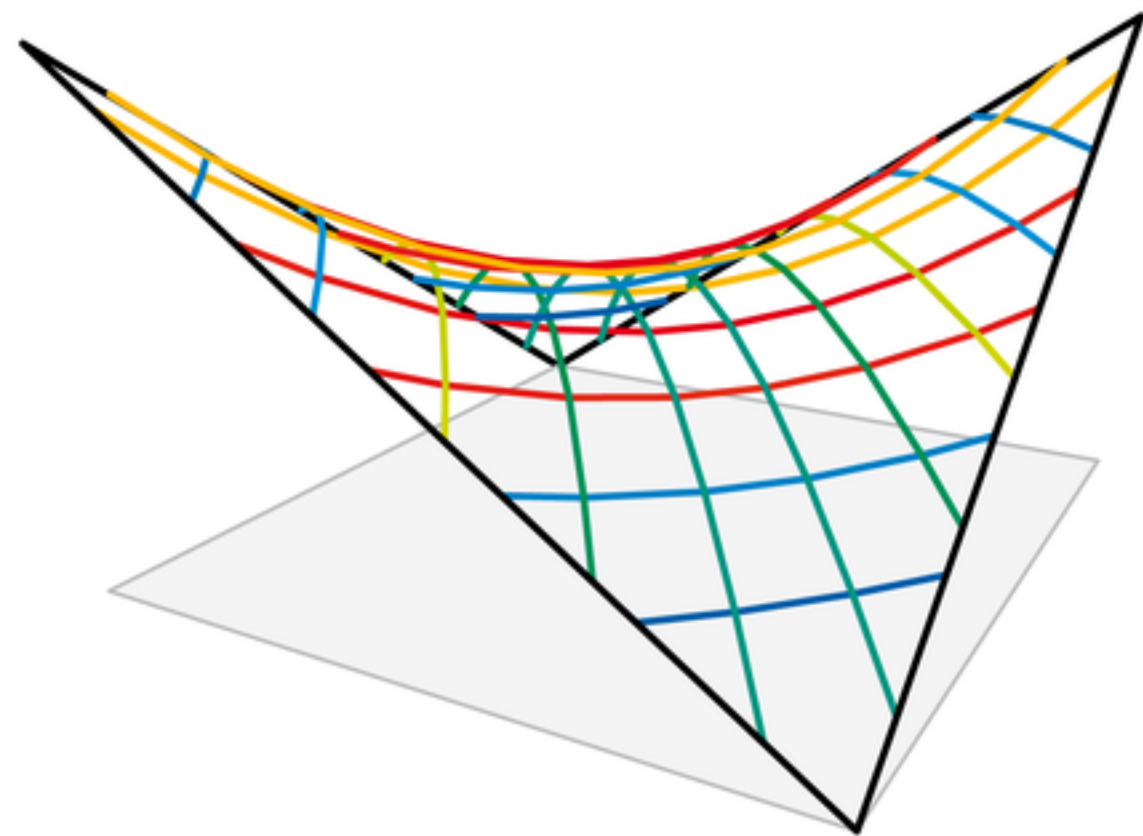
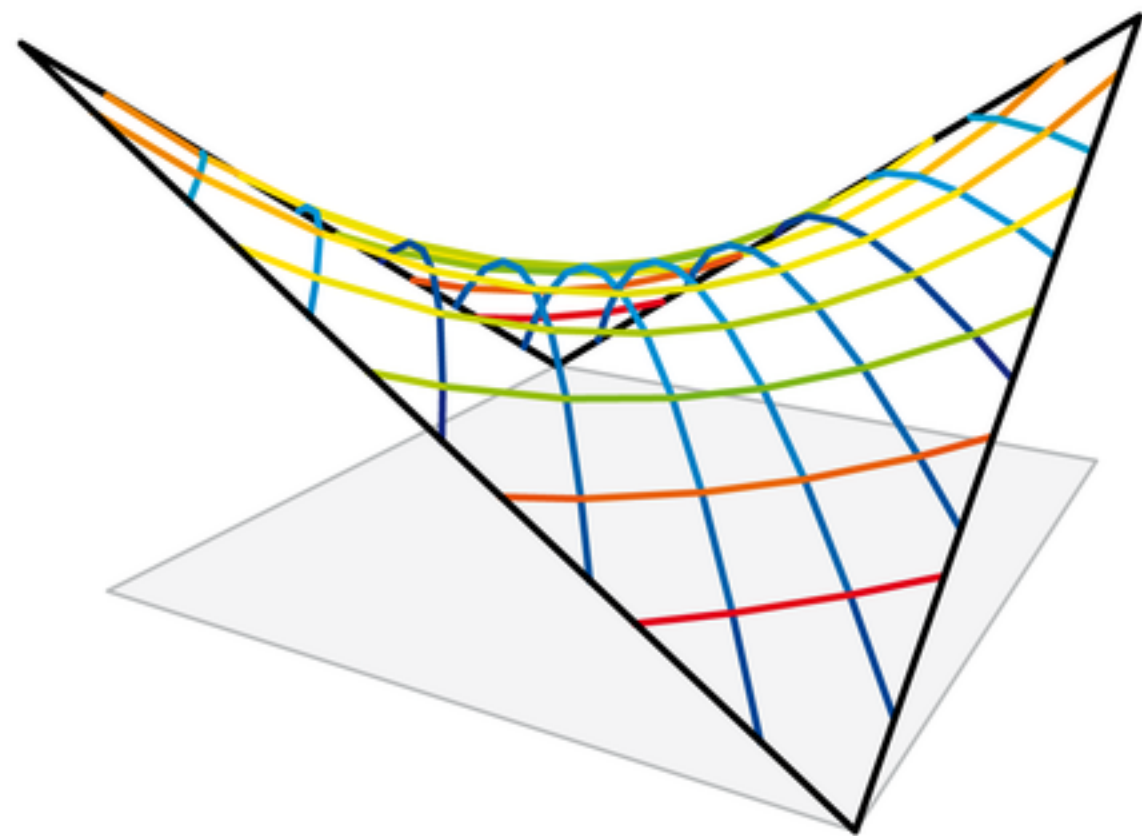






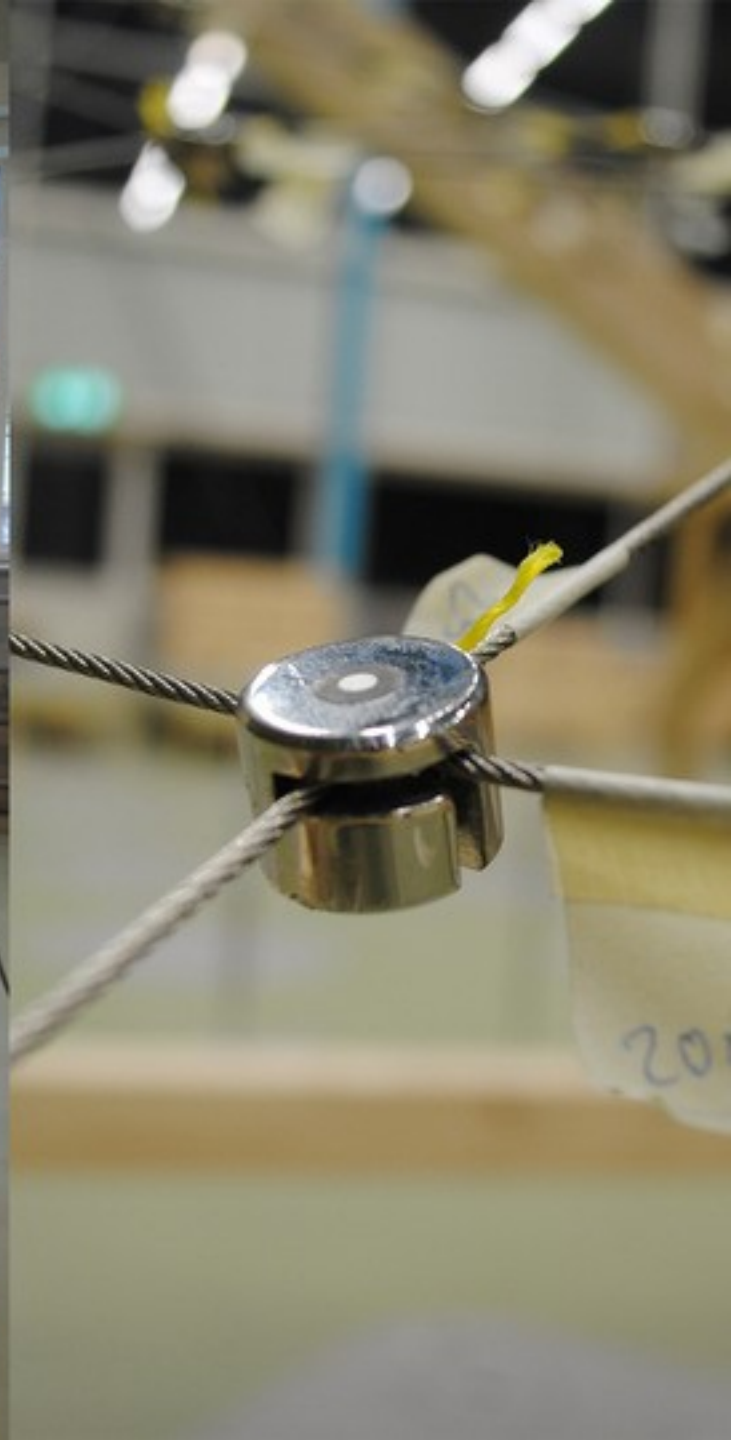








DO NOT TOUCH
REPAIR





















ESCOBEDO

























Temporary permits on the Lower East side.
follownyc.com
188

ETH zürich
BRG

















Material and Construction
for Sustainable and Affordable
in South Africa

"Form is a good enough for good design"

48%
33%
62%

...







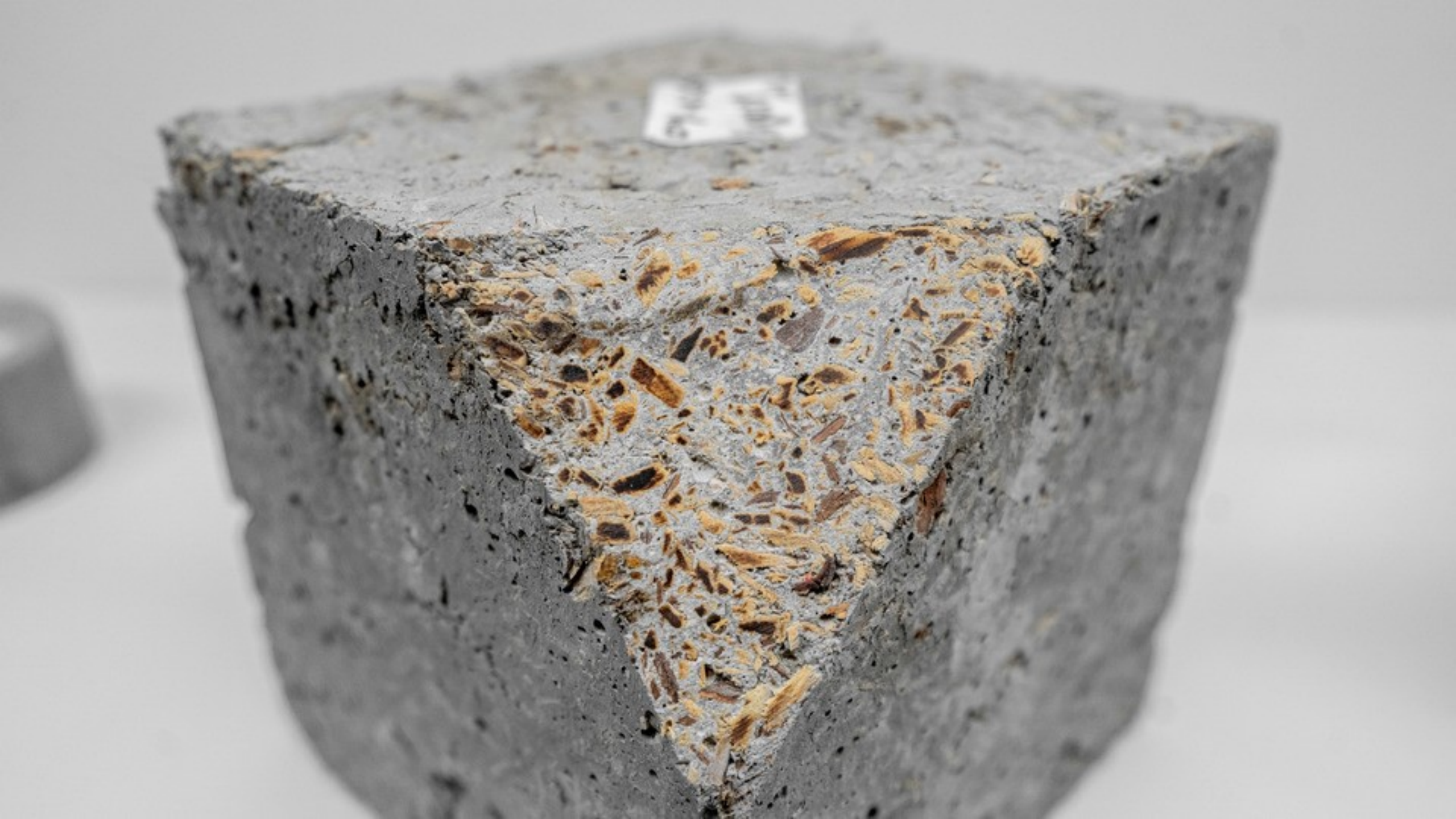
Material and Construction Innovation for Sustainable and Affordable Housing in South Africa

"Everyone is good enough for good design."

- 40%
- 35%
- 40%

Text describing the project's goals and achievements.





Material and Construction Innovation
for Sustainable and Affordable Housing
in South Africa

"Innovate a good enough for your stage!"









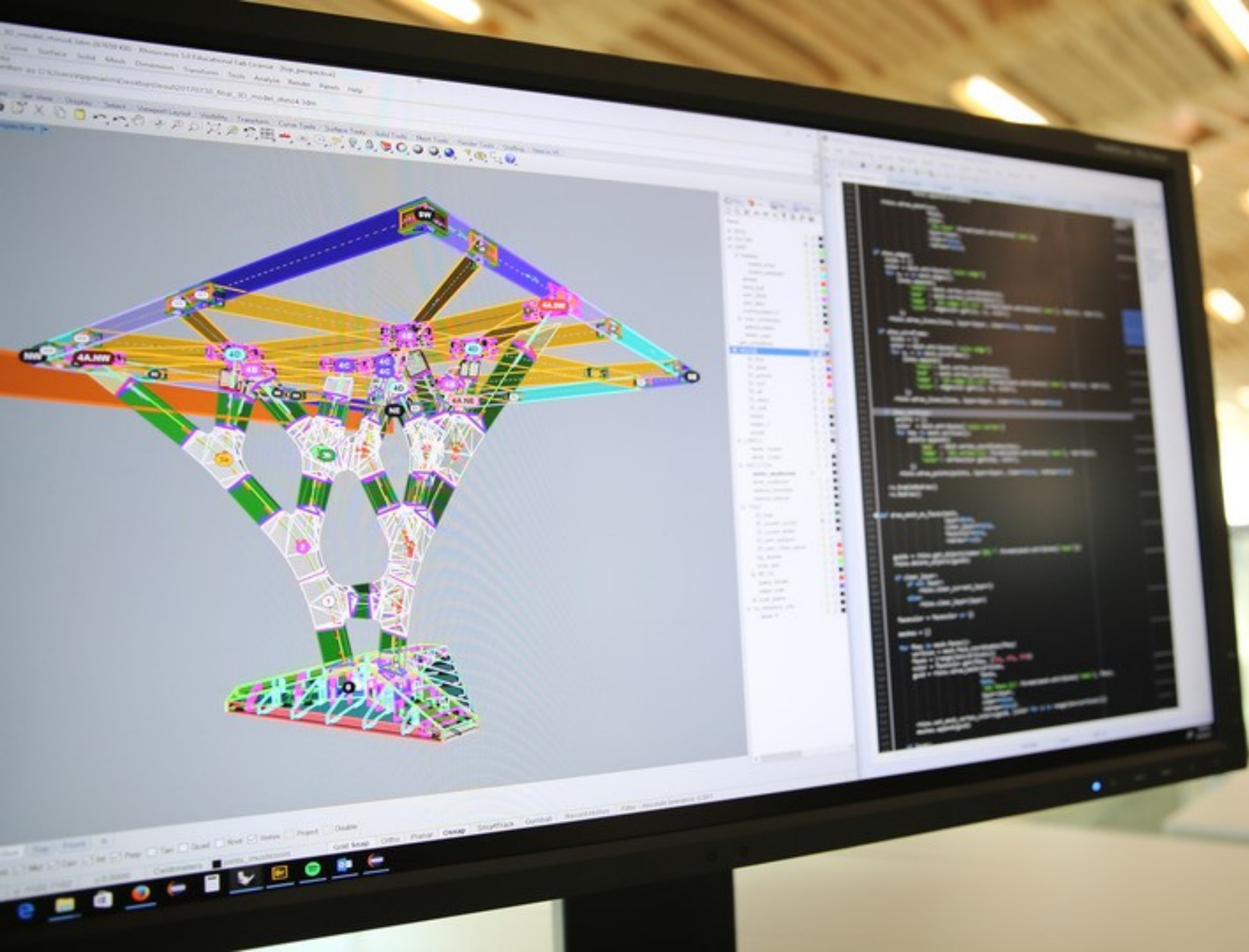


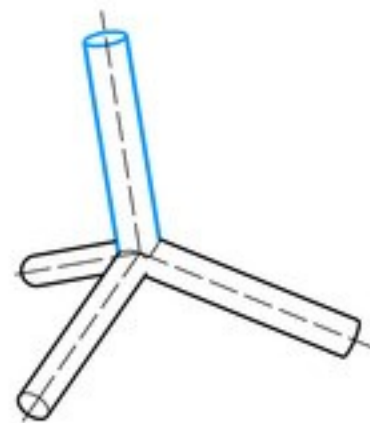
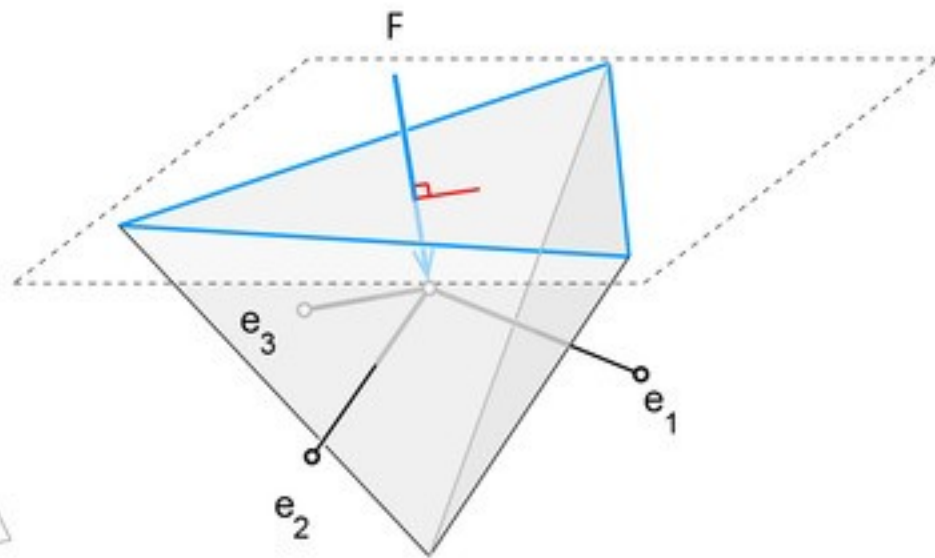
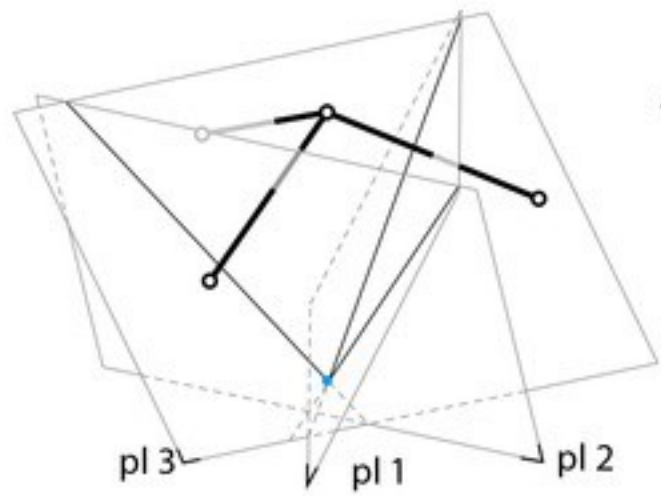


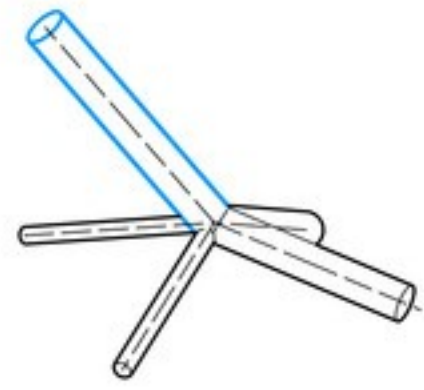
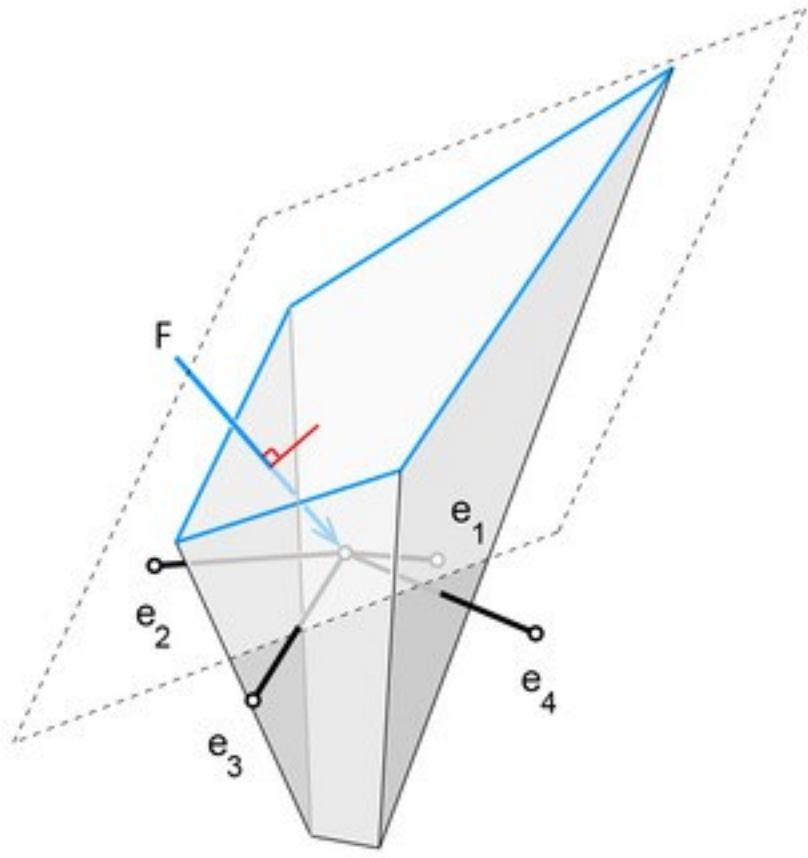
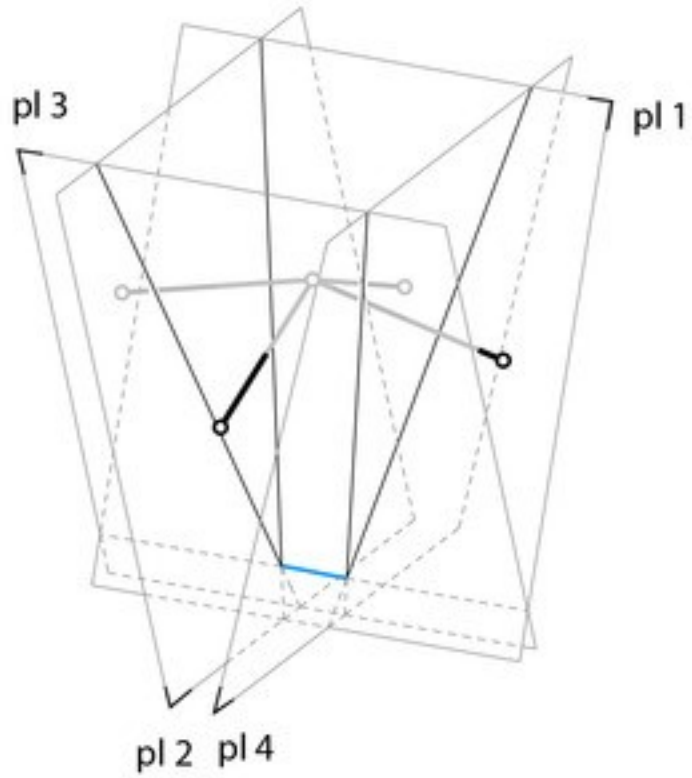


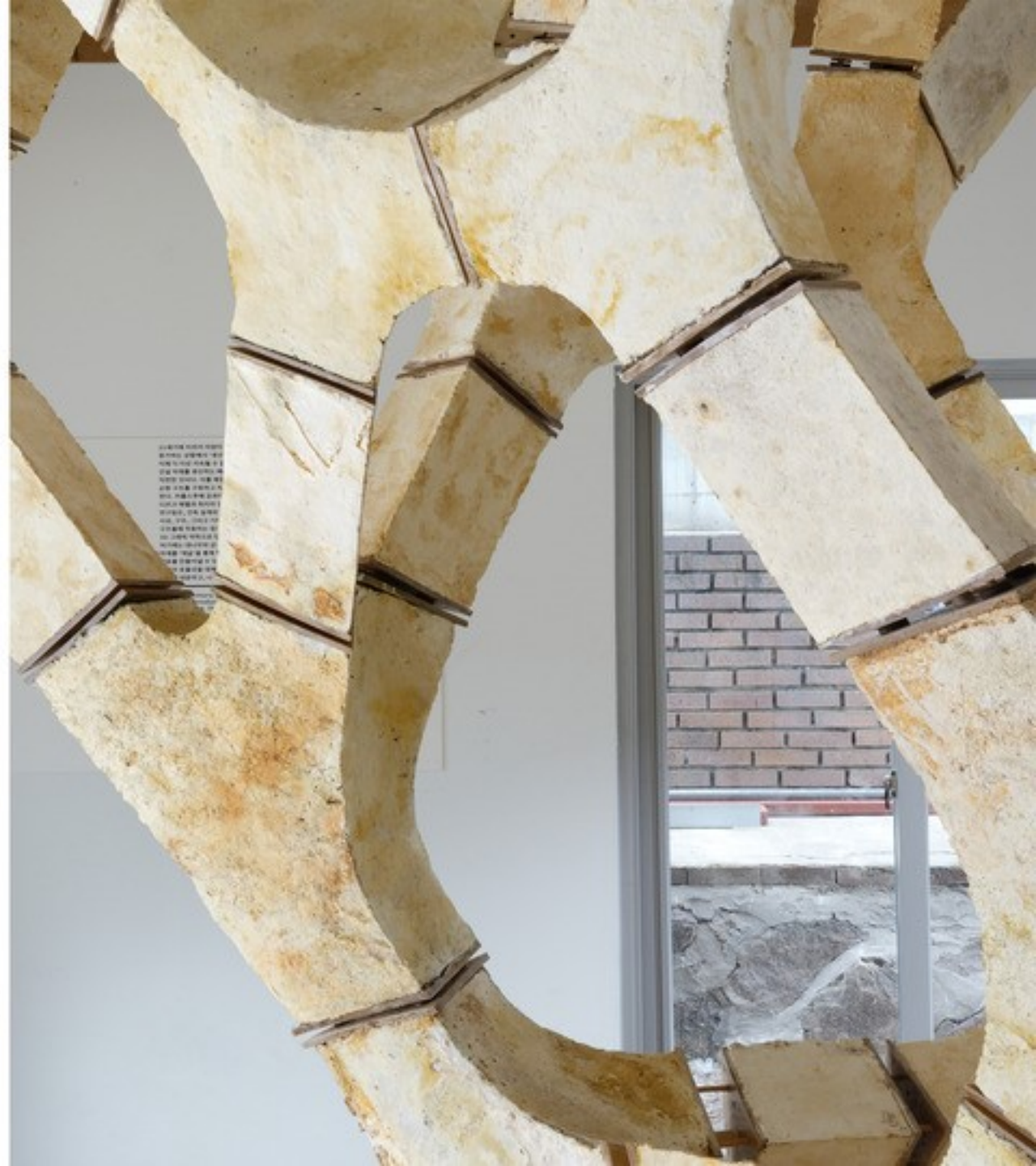


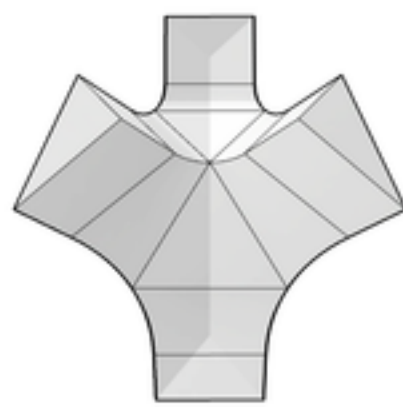
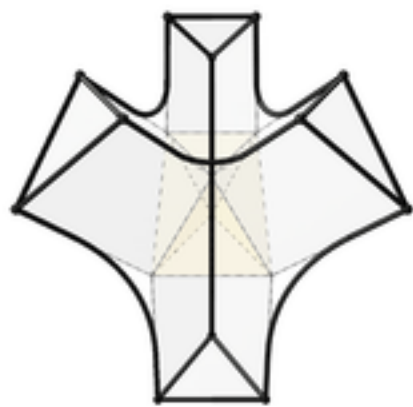
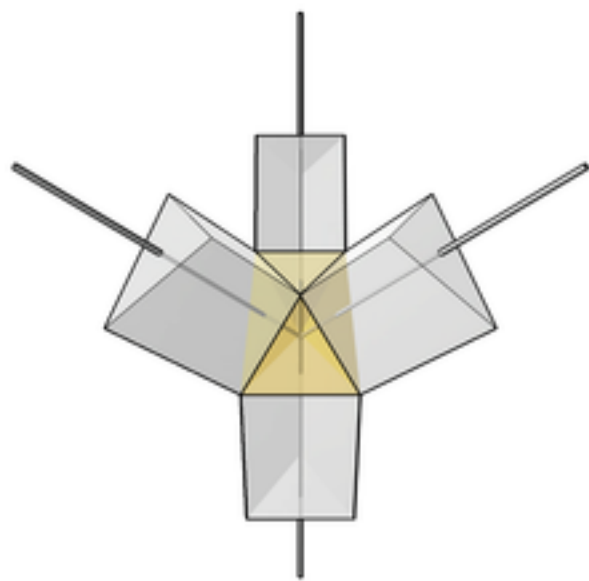
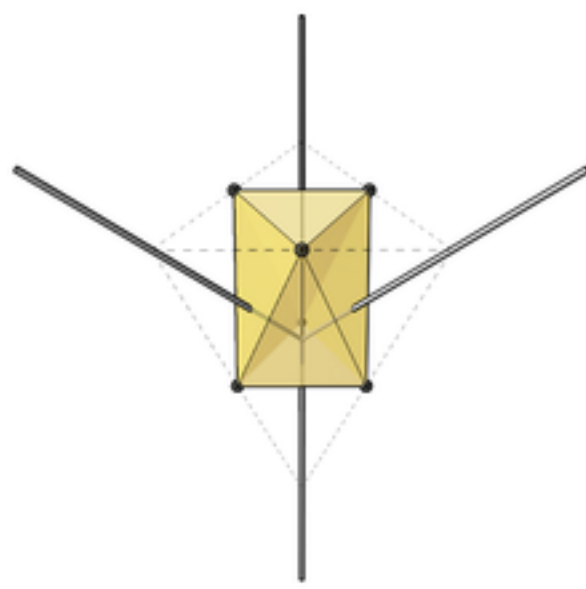
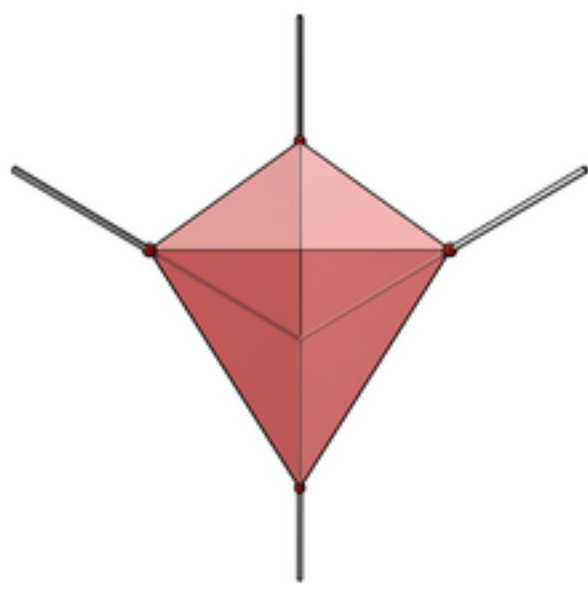


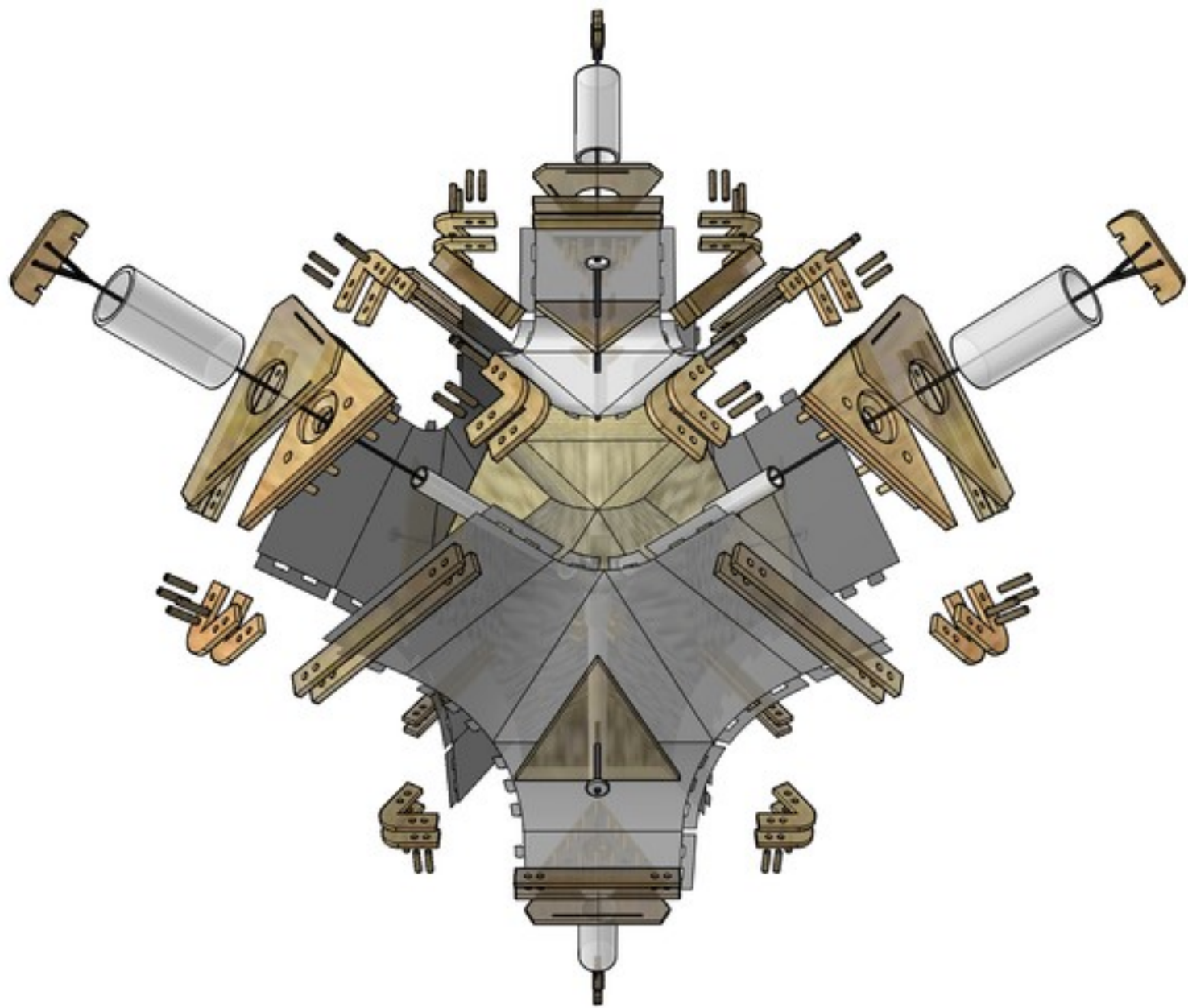
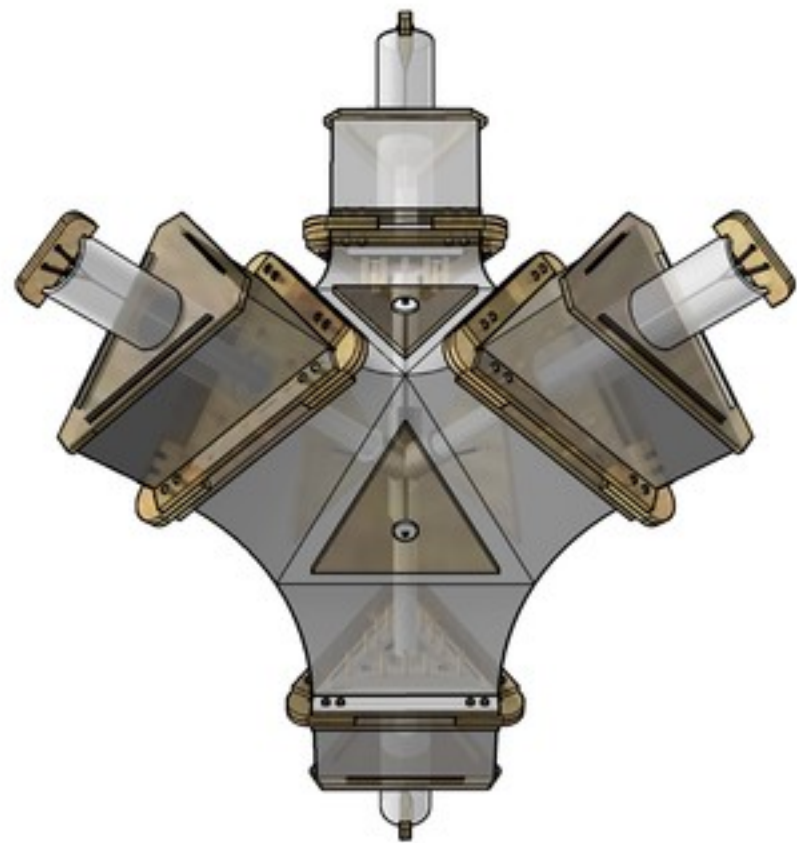


























M-0
M-1
M-2







2016-11-30





